

Refrigeration Components

The widest range of refrigeration
solutions and spare parts



Whatever
you need,
we've got it

We are REPA!



REPA is Europe's leading distributor of spare parts for foodservice and refrigeration equipment, coffee and vending machines, and a trusted partner to OEMs, delivering the right part at the right time.

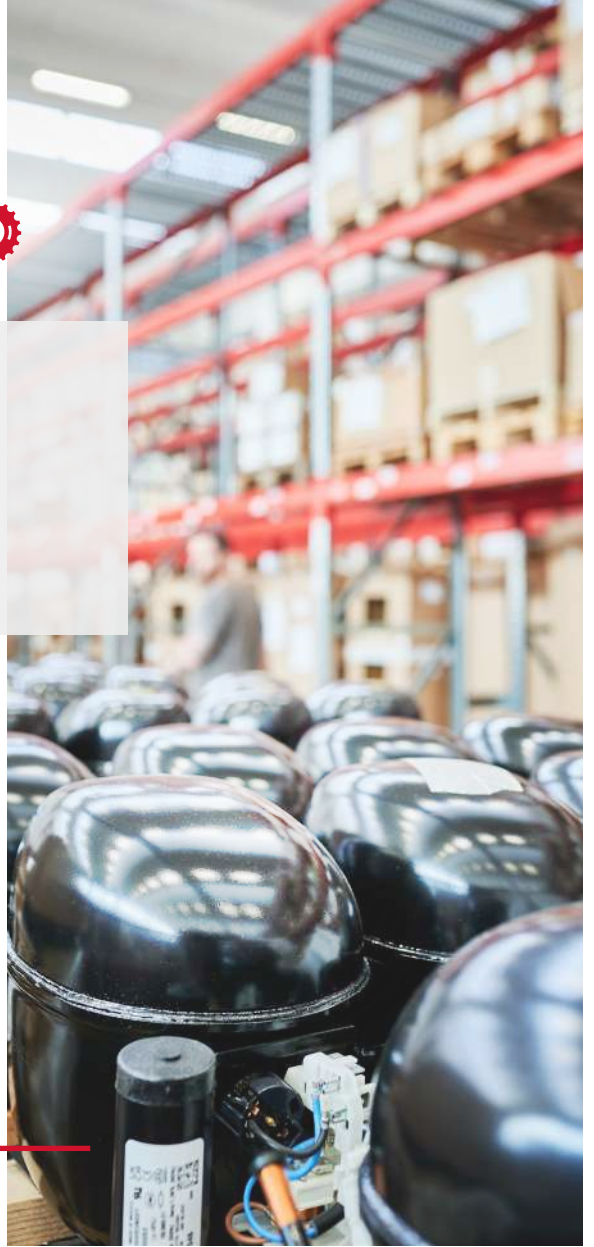

Our Expertise at Your Service

By working directly with the leading brands in the refrigeration industry, REPA combines extensive sector experience with an unmatched assortment of professional components – from compressors and condensing units to fan motors, electronic controllers, components and gaskets.

With one of the widest product ranges in the market and a large inventory always available and ready to ship, REPA ensures fast, reliable support for installers and service technicians.

We Have the Right Tools to Support Your Business



A World of Parts,
All in One Place



Search via
Manufacturer's Code



Exploded Drawings



360° Picture

*Fresh updates,
just a scan
away!*



REPA IT



REPA DE

 **REPA**

FIND IT.

GET IT.

FIX IT.

FAST!

repagroup.com

Our Strengths, Your Advantages!

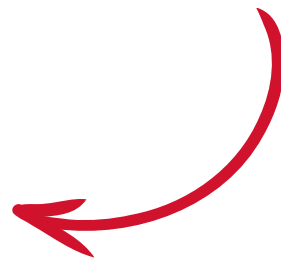

**An Unrivaled
Inventory
of Spares**



**Superior Original
Spare Parts Solutions
for Our Partners**



**Lightning-Fast
Delivery**



**User-Friendly
Technology
Made for You**



**The Customer
Service
You Deserve**

Table of contents

Compressors	6	Gas taps and accessories	137
Embraco	7	Capillaries	139
Secop	14	Copper pipes	140
Cubigel	18	Vibration isolators for copper pipes	142
Tecumseh	22	Insulators	143
Danfoss Maneurop	27	Mechanical microswitches	144
Accessories	28	HVAC	146
Scroll	29	Cold room spare parts	147
Semi-hermetic	30		
Refrigeration units	32	Gaskets	161
Condensing units	33	Snap-in gasket profiles	162
Monoblocks	44	Middle-edge gasket profiles	170
Electronic controllers	47		
Electronic controllers	48		
Electrical boards	70		
Remote controlling	75		
Probes	76		
Axial motor fans	78		
Fan motors	86		
Components	96		
Valves	97		
Solenoid valves	105		
Compensations valves	109		
Filters	110		
Thermostats	117		
Telethermometers	120		
Evaporators LUVE SHS	122		
Evaporators for counters	123		
Condensers	124		
Heating elements	126		
Drip trays	130		
Potentiometers	131		
Pressure switches	132		
Refrigerant leaks detections	135		
Liquid receives	136		

Click me!
I'm an interactive
index

COMPRESSORS

SECCP

embraco

cubigel
compressors

Danfoss

COPELAND



The **compressor** is the heart of any refrigeration or air-conditioning system: it draws in low-pressure, low-temperature refrigerant vapor, compresses it to a higher pressure and temperature, and sends it to the condenser to continue the refrigeration cycle.

Below is a table comparing hermetic, scroll, and semi-hermetic compressors, each with specific construction and performance characteristics designed to meet different application requirements.

Type	Description	Applications	Advantages
Hermetic Compressors	Hermetic compressors are sealed units designed for compact applications and plug-in systems.	Commonly used in refrigerated cabinets, display cases and small cold rooms.	Small size, low noise level minimal maintenance.
Scroll Compressors	Scroll compressors use two interleaved spirals to achieve continuous and stable compression.	Widely used in air conditioning, heat pumps and commercial refrigeration.	Very low vibration, high energy efficiency, quiet operation and excellent reliability..
Semi-Hermetic Compressors	Semi-hermetic compressors are designed for professional systems where internal maintenance is required.	Suitable for medium to high capacity systems, such as industrial plants and supermarket racks.	Long service life, repairable design and a wide range of configurations.

More value
for you

- 1** The widest compressor **portfolio**, both in brands and models.
- 2** Electrical parts pre-mounted to **save time** and reduce costs.
- 3** Safe and reliable **packaging**, with fast and secure shipping.
- 4** Order single units, full pallets or mixed pallets for **maximum flexibility**.

COMPRESSORS EMBRACO R134a LBP



embraco

REPA IT Code	REPA DE Code	Model	Motor power HP	Displacement cm ³	Power supply Volt/Ph/Hz
3070290	LF3070290	EMIE30HER	1/12	2.83	220-240V/1/50-60
41687205	41687205	EMI45HER	1/8	3.77	220-240V/1/50-60
3070372	605313	EMY3111Z	1/8	4.53	220-240/1/50
3070376	605314	EMY3115Z	1/6	6.09	220-240/1/50
3070342	LF3070342	EMIE65HER	1/6	5.19	220-240/1/50
3070296	LF3070296	EMYE70HEP	1/5	5.96	220-240/1/50-60
3070237	LF3070237	NEK2116Z	1/5	7.40	220-240/1/50
3070231	LF3070231	NEK1118Z	1/4L	8.40	220-240/1/50
3070185	605119	NE2121Z	1/4	9.27	220-240/1/50
5063911	LF5063911	NE2130Z	1/3	12.11	220-240/1/50
2101596	605265	NE2134Z	1/2	14.28	220-240/1/50
7119817	LF7119817	NEK2140Z	1/2	16.80	220-240/1/50

COMPRESSORS EMBRACO R134a MBP



embraco

REPA IT Code	REPA DE Code	Model	Motor power HP	Displacement cm ³	Power supply Volt/Ph/Hz
3070281	LF3070281	EM30HHR	1/10	3.00	220-240/1/50
3070282	LF3070282	EM45HHR	1/8	3.80	220-240/1/50
5029895	LF5029895	EM55HHR	1/6	4.60	220-240/1/50
3070162	605016	EM65HHR	1/6	5.50	220-240/1/50
5037602	LF5037602	EGAS100HLR	1/4	7.90	220-240/1/50
3070286	LF3070286	FFI8.5HAK	1/4	7.20	220-240/1/50
3070287	LF3070287	FFI10HAK	1/3	9.10	220-240/1/50
3070288	605244	FFI12HBK	1/3	11.10	220-240/1/50

Embraco compressors

COMPRESSORS EMBRACO R134a HMBP



embraco

REPA IT Code	REPA DE Code	Model	Motor power HP	Displacement cm ³	Power supply Volt/Ph/Hz
3070229	LF3070229	EMT37HDP	1/10	3.40	220-240/1/50
3070107	605086	EMT45HDR	1/8	3.97	220-240/1/50
3070158	605181	EMT50HDP	1/6	4.50	220-240/1/50
3070218	605166	EMT6144Z	1/6	5.20	220-240/1/50
3070219	605189	EMT6160Z	1/5	6.76	220-240/1/50
3070172	605308	NEK6160Z	1/4L	7.28	220-240/1/50
3070220	605135	EMT6170Z	1/4L	7.69	220-240/1/50
3070173	605001	NEK6170Z	1/4	8.40	220-240/1/50
3070174	605209	NEK6187Z	1/3	10.00	220-240/1/50
3070175	605208	NEK6210Z	3/8	12.12	220-240/1/50
3070326	605263	NEU6210Z	3/8	12.12	220-240/1/50
3070176	605210	NEK6212Z	1/2L	14.30	220-240/1/50
3070327	LF3070327	NEU6212Z	1/2L	14.30	220-240/1/50
3070177	605237	NEK6214Z	1/2	16.80	220-240/1/50
3070328	LF3070328	NEU6214Z	1/2	16.80	220-240/1/50
3070178	605079	NT6215Z	1/2	17.40	220-240/1/50
3070179	LF3070179	NT6217Z	5/8	20.40	220-240/1/50
3070180	LF3070180	NT6220Z	3/4	22.40	220-240/1/50
3070050	605254	NJ6220Z	3/4	26.20	220-240/1/50
3070053	LF3070053	NJ6220ZX	3/4	26.20	380-440/3/50-60
3070052	605175	NJ6226Z	1	34.37	220-240/1/50
3070054	LF3070054	NJ6226ZX	1	34.37	380-440/3/50-60

COMPRESSORS EMBRACO R404a-R507 LBP



embraco

REPA IT Code	REPA DE Code	Model	Motor power HP	Displacement cm ³	Power supply Volt/Ph/Hz
3070230	LF3070230	EMT2117GK	1/5	4.50	220-240/1/50
3070224	605213	EMT2121GK	1/4L	5.20	220-240/1/50
3070163	LF3070163	NEK2121GK	1/4L	5.45	220-240/1/50
3070225	605206	EMT2125GK	1/4	5.96	220-240/1/50
3070164	LF3070164	NEK2125GK	1/4	6.20	220-240/1/50
3070315	605264	EMT2130GK	3/8	6.76	220-240/1/50
3070165	605334	NEK2130GK	1/3	7.40	220-240/1/50
3070166	605152	NEK2134GK	1/3	8.78	220-240/1/50
3070325	605256	NEU2140GK	1/2L	8.78	220-240/1/50
3070120	605186	NEK2150GK	1/2	12.12	220-240/1/50
3070324	LF3070324	NEU2155GK	1/2	12.12	220-240/1/50
3070167	605144	NEK2168GK	3/4	14.30	220-240/1/50
3070299	LF3070299	NEU2168GK	3/4	14.30	220-240/1/50
3070168	605304	NT2168GK	3/4	14.50	220-240/1/50
3070300	605164	NEU2178GK	3/4	16.80	220-240/1/50
3070169	LF3070169	NT2178GK	3/4	17.40	220-240/1/50
3070170	605078	NT2180GK	1	20.40	220-240/1/50
3070171	605260	NT2192GK	1.1	22.40	220-240/1/50
3070123	605174	NJ2192GJ	1.2	26.00	220-240/1/50
3070257	LF3070257	NJ2192GK Gemini with oil equalization	1.2	26.00	220-240/1/50
3070226	605235	NT2212GK	1.3	27.80	220-240/1/50
3070045	605081	NJ2212GK	1.7	34.37	220-240/1/50
3070258	LF3070258	NJ2212GK Gemini with oil equalization	1.7	34.37	220-240/1/50
3070047	LF3070047	NJ2212GS	1.7	34.37	380-440/3/50-60

Embraco compressors

COMPRESSORS EMBRACO R404a-R507 HMBP



embraco

REPA IT Code	REPA DE Code	Model	Motor power HP	Displacement cm ³	Power supply Volt/Ph/Hz
3070215	605130	EMT6144GK	1/5	3.97	220-240/1/50
3070216	605004	EMT6152GK	1/4L	4.50	220-240/1/50
3070181	605149	NEK6144GK	1/4L	4.52	220-240/1/50
3070217	605139	EMT6165GK	1/4	5.20	220-240/1/50
3070182	605309	NEK6165GK	1/4	6.20	220-240/1/50
3070183	605162	NEK6181GK	1/3	7.28	220-240/1/50
3070184	605161	NEK6210GK	3/8	8.78	220-240/1/50
3070331	LF3070331	NEU6212GK	3/8	8.78	220-240/1/50
3070040	605125	NEK6213GK	1/2	12.12	220-240/1/50
3070330	LF3070330	NEU6215GK	1/2	12.12	220-240/1/50
3070191	LF3070191	NT6217GK	1/2	12.60	220-240/1/50
3070186	605178	NEK6217GK	5/8	14.30	220-240/1/50
3070187	605227	NT6220GK	5/8	14.50	220-240/1/50
3070188	605132	NT6222GK	3/4	17.40	220-240/1/50
3070274	LF3070274	NT6224GK	1	20.44	220-240/1/50
3070189	605165	NT6226GK	1.1	22.40	220-240/1/50
3070010	605030	NJ9226GK	1.1	21.70	230/1/50
3070020	LF3070020	NJ9226GS	1.1	21.70	380-440/3/50-60
3070018	605190	NJ9232GK	1.2	26.20	230/1/50
3070027	LF3070027	NJ9232GS	1.2	26.20	380-440/3/50-60
3070019	605177	NJ9238GK	1.5	32.70	230/1/50
3070028	LF3070028	NJ9238GS	1.5	32.70	380-440/3/50-60

COMPRESSORS EMBRACO R290 LBP



embraco

REPA IT Code	REPA DE Code	Model	Motor power HP	Displacement cm ³	Power supply Volt/Ph/Hz
7155064	23522006	EMC3117U	1/4	3.97	220-240/1/50
3070270	LF3070270	EMT2117U	1/5	4.50	220-240/1/50
7153354	23522129	EMC3119U	1/4	4.53	220-240/1/50
41530349	41530349	EMC3121U	1/4	5.54	220-240/1/50
3070260	605215	EMT2121U	1/3	5.56	220-240/1/50
3070267	LF3070267	EMT2125U	1/3	5.96	220-240/1/50
3070261	605346	EMT2130U	1/2	6.76	220-240/1/50
5187128	LF5187128	EMC3130U	1/3	6.92	220-240/1/50
3070268	605274	NEK2134U	1/2	9.99	220-240/1/50
41530348	41530348	EHU2155U	3/4	12.21	220-240/1/50
3070259	605214	NEK2150U	1/2	13.54	220-240/1/50
3070332	605243	NEU2155U	1/2	13.54	220-240/1/50
3070269	605204	NEK2160U	3/4	16.80	220-240/1/50
3070301	LF3070301	NEU2168U	3/4	16.80	220-240/1/50
3070487	LF3070487	NEU2178U	1	18.70	220-240/1/50
3070271	605202	NT2170U	3/4	20.44	220-240/1/50
3070272	605199	NT2180U	1	22.37	220-240/1/50
3070311	605203	NT2210U	1	27.80	220-240/1/50
3070515	LF3070515	NTX2213U	1 1/2	33.42	220-240/1/50

Embraco compressors

COMPRESSORS EMBRACO R290 HMBP



embraco

REPA IT Code	REPA DE Code	Model	Motor power HP	Displacement cm ³	Power supply Volt/Ph/Hz
3070262	605200	EMT6144U	1/4	4.50	220-240/1/50
3070263	605201	EMT6152U	1/4	5.19	220-240/1/50
3070485	LF3070485	NEK6152U	1/4	5.44	220-240/1/50
3070264	605198	EMT6165U	1/3	5.96	220-240/1/50
3070486	LF3070486	NEK6165U	1/4	6.20	220-240/1/50
3070265	LF3070265	NEK6181U	1/3	7.28	220-240/1/50
3070273	LF3070273	NEK6210U	1/3	8.77	220-240/1/50
3070310	LF3070310	NEU6210U	1/3	8.77	220-240/1/50
3070333	LF3070333	NEU6212U	1/2	9.99	220-240/1/50
3070266	605305	NEK6213U	1/2	12.11	220-240/1/50
3070302	LF3070302	NEU6214U	3/4	12.11	220-240/1/50
3070303	LF3070303	NEU6217U	3/4	14.28	220-240/1/50
3070411	605370	NEU6220U	3/4	16.80	220-240/1/50
3070304	LF3070304	NT6220U	3/4	17.39	220-240/1/50
3070305	605331	NT6222U	1	20.44	220-240/1/50
3070306	LF3070306	NT6224U	1	22.37	220-240/1/50
3070307	LF3070307	NT6230U	1 1/4	27.80	220-240/1/50
3070516	LF3070516	NTX6238U	1 1/2	33.42	220-240/1/50

COMPRESSORS EMBRACO R600a HMBP



embraco

REPA IT Code	REPA DE Code	Model	Motor power HP	Displacement cm ³	Power supply Volt/Ph/Hz
3070384	605083	EMT30CDP	1/12	4.50	220-240/1/50
5215388	605085	EMU5132Y	1/7	6.76	220-240/1/50
3070359	LF3070359	EMT6144Y	1/5	9.04	220-240/1/50
5087248	605248	NEK6160Y	1/4-	12.11	220-240/1/50
3070360	LF3070360	NEK6170Y	1/4+	14.28	220-240/1/50

Embraco compressors

COMPRESSORS EMBRACO R600a LBP



embraco

REPA IT Code	REPA DE Code	Model	Motor power HP	Displacement cm ³	Power supply Volt/Ph/Hz
3070377	LF3070377	EMX26CLC	1/10	5.19	220-240/1/50
3070378	605315	EMX32CLC	1/10	5.96	220-240/1/50
3070379	605316	EMC40CLT	1/8	7.23	220-240/1/50
3070373	605257	EMD46CLT	1/7	7.96	220-240/1/50
3070381	605247	EMX55CLC	1/6	9.04	220-240/1/50
5163745	LF5163745	EMY3118Y	1/5	12.21	220-240/1/50
3070255	LF3070255	EMX80CLT	1/7	12.21	220-240/1/50

Secop compressors

COMPRESSORS SECOP R134a HMBP



SECOP

REPA IT Code	REPA DE Code	Model	Motor power HP	Displacement cm ³	Power supply Volt/Ph/Hz
3070078	605123	TL4G	1/8	3.86	220-240/1/50-60
3070077	605052	TL5G	1/6	5.10	220-240/1/50-60
3070227	605059	NL6.1MF	1/5L	6.13	220-240/1/50-60
3070256	605055	FR6G	1/5L	6.23	220-240/1/50-60
41670788	41670788	FRK8.5G	1/4	6.60	220-240/1/50-60
3070079	605088	FR7.5G	1/5	6.93	220-240/1/50-60
3070221	605063	NL7.3MF	1/5	7.27	220-240/1/50-60
3070207	605089	NL8.4MF	1/4	8.35	220-240/1/50-60
3070070	605054	FR10G	1/4	9.05	220-240/1/50-60
3070208	605060	NL10MF	1/3L	10.10	220-240/1/50-60
3070071	605221	SC10G	1/3L	10.29	220-240/1/50-60
3070239	605193	NL11MF	1/3	11.15	220-240/1/50
3070154	605205	FR11G	1/3L	11.15	220-240/1/50
3070067	605087	SC12G	1/3	12.87	220-240/1/50-60
3070068	605077	SC15G	3/8	15.28	220-240/1/50-60
3070069	605076	SC18G	1/2	17.69	220-240/1/50-60
3070349	LF3070349	SC18MFX	1/2	17.69	220-240/1/50-60
3070155	605194	SC21G	5/8	20.95	220-240/1/50-60
7112530	LF7112530	SC21MFX	5/8	20.95	220-240/1/50
3070358	LF3070358	GS26MFX	3/4	26.30	220-240/1/50
5064841	LF5064841	GS34MFX	1	33.80	220-240/1/50

COMPRESSORS SECOP R404a-R507 LBP



SECOP

REPA IT Code	REPA DE Code	Model	Motor power HP	Displacement cm ³	Power supply Volt/Ph/Hz
3070350	LF3070350	TL4CL	1/6L	3.86	220-240/1/50
3070289	LF3070289	TL4.5CLX	1/6	4.63	220-240/1/50
3070214	LF3070214	FR6CL	1/5	6.23	220-240/1/50
3070280	LF3070280	FR7.5CL	1/4L	6.93	220-240/1/50
3070348	LF3070348	NL7CLX	1/4L	7.27	220-240/1/50
3070344	LF3070344	NL8.4CLX	1/4	8.35	220-240/1/50
3070159	LF3070159	SC10CL	1/3	10.29	220-240/1/50
3070297	605179	SC10CLX	1/3	10.29	220-240/1/50
3070073	605057	SC12CL	3/8	12.87	220-240/1/50
3070074	605058	SC15CL	1/2	15.28	220-240/1/50
3070293	605330	SC15CLX.2	1/2	15.28	220-240/1/50
3070075	605303	SC18CL	5/8	17.69	220-240/1/50
3070294	605056	SC18CLX.2	5/8	17.68	220-240/1/50
3070076	605082	SC21CL	7/8	20.95	220-240/1/50
3070356	LF3070356	GS26CLX	1 1/4	26.30	220-240/1/50

COMPRESSORS SECOP R404a-R507 HMBP



SECOP

REPA IT Code	REPA DE Code	Model	Motor power HP	Displacement cm ³	Power supply Volt/Ph/Hz
35567470	35567470	NL6.1MLX	1/4	6.13	220-240/1/50
3070361	LF3070361	NF7MLX	1/4P	7.27	220-240/1/50 208-230/1/60
3070353	LF3070353	SC10MLX	1/3	10.29	220-240/1/50 208-230/1/60
3070352	605336	SC12MLX	1/2	12.87	220-240/1/50 208-230/1/60
3070346	605146	SC15MLX	5/8	15.28	220-240/1/50
3070355	LF3070355	SC18MLX	3/4	17.68	220-240/1/50
3070351	605113	SC18MLX.3	3/4	17.68	220-240/1/50
3070354	LF3070354	GS21MLX	1	21.20	220-240/1/50
2106262	LF2106262	GS26MLX	1 1/4	26.30	220-240/1/50
3070357	LF3070357	GS34MLX	1 1/2	33.80	220-240/1/50

Secop compressors

COMPRESSORS SECOP R290 LBP



SECOP

REPA IT Code	REPA DE Code	Model	Motor power HP	Displacement cm ³	Power supply Volt/Ph/Hz
3070334	605259	TL5CN	1/5	5.08	220-240/1/50
3070335	LF3070335	NL7CN	1/3	7.27	220-240/1/50
3070336	LF3070336	NL9CN	3/8	8.35	220-240/1/50
3070389	605349	NLE11CNL	1/2	11.15	220-240/1/50
3070393	605352	NLE12.6CNL	1/2	12.55	220-240/1/50
3070339	605261	SC12CNX.2	1/2	12.87	220-240/1/50
3070329	LF3070329	SC15CNX.2	5/8	15.28	220-240/1/50
3070308	LF3070308	SC18CNX.2	3/4	17.69	220-240/1/50
3070338	605267	SC21CNX.2	1	20.95	220-240/1/50

COMPRESSORS SECOP R290 MLBP



SECOP

REPA IT Code	REPA DE Code	Model	Motor power HP	Displacement cm ³	Power supply Volt/Ph/Hz
3070390	605350	DLE4CN	1/6	4.00	220-240/1/50
3070385	605268	DLE4.8CN	1/5	4.80	220-240/1/50
3070386	605347	KLF5.6CND	1/4	5.60	220-240/1/50
3070387	605269	KLF6.6CND	1/4	6.50	220-240/1/50
3070394	605353	KLF7.7CND	1/3	7.70	220-240/1/50
3070388	605348	NLE8.8CN	3/8	8.76	220-240/1/50
5128371	605359	NLE10CN	3/8	10.09	220-240/1/50

INVERTER COMPRESSORS SECOP R290 LBP/MBP



SECOP

REPA IT Code	REPA DE Code	Model	Displacement cm ³	Electric diagram	Power supply Volt/Ph/Hz
3070497	LF3070497	DLV5.7CN	5.70	VARIABLE SPEED DRIVE	220-240/1/50-60
3070408	605368	NLV12.6CN	12.60	VARIABLE SPEED DRIVE	220-240/1/50-60
3070498	LF3070498	SLVE18CN	17.70	VARIABLE SPEED DRIVE	220-240/1/50-60

COMPRESSORS SECOP R600a LBP



SECOP

REPA IT Code	REPA DE Code	Model	Motor power HP	Displacement cm ³	Power supply Volt/Ph/Hz
D070002	LFD070002	TLES4.8KK.3	1/10	4.80	220-240/1/50
D070003	LFD070003	TLES5.7KK.3	1/8	5.70	220-240/1/50
D070004	LFD070004	TLES6.5KK.3	1/7	6.50	220-240/1/50
D070005	LFD070005	TLES7,5KK.3	1/6	7.50	220-240/1/50
41729197	41729197	HXK80AA	1/6	8.10	220-240/1/50
D070007	LFD070007	HMK95AA	1/5+	9.50	220-240/1/50
D070010	LFD070010	NLX15 KK.3	1/3+	15.00	220-240/1/50

Cubigel compressors

COMPRESSORS CUBIGEL R134a LBP



cubigel
compressors

REPA IT Code	REPA DE Code	Model	Motor power HP	Displacement cm ³	Power supply Volt/Ph/Hz
3070363	LF3070363	L22HL	1/20	2.20	220-240/1/50
3070371	LF3070371	L30HL	1/12	3.10	220-240/1/50
3070370	LF3070370	B43H	1/10	4.30	220-240/1/50-60
3070196	605197	GL60AA	1/6	6.00	220-240/1/50
D070043	10568036	GLY80AA	1/5	8.10	220-240/1/50
3070606	LF3070606	GLY90AA	1/4	9.10	220-240/1/50
3070198	LF3070198	GL99AA	1/3	10.00	220-240/1/50

COMPRESSORS CUBIGEL R134a HMBP



cubigel
compressors

REPA IT Code	REPA DE Code	Model	Motor power HP	Displacement cm ³	Power supply Volt/Ph/Hz
3070364	LF3070364	B30G	1/10	3.10	220-240/1/50
3070368	LF3070368	B35GL	1/10	3.50	220-240/1/50
3070369	605282	B38G	1/8	3.80	220-240/1/50
3070011	605012	GU45TG	1/6	4.50	220-240/1/50
3070012	605007	GL60TB	1/5	5.70	220-240/1/50
3070013	10626597	GE70TG	1/4L	7.60	220-240/1/50
3070014	605009	GL90TB	1/4	8.80	220-240/1/50
3070365	605312	GLY12RAa	1/3	10.70	220-240/1/50
3070619	23158485	GPY12RAa	3/8	12.10	220-240/1/50
3070051	605011	GP14TB	3/8	14.00	220-240/1/50
3070156	605170	GP16TB	3/8	16.00	220-240/1/50
3070016	605182	GPT18RA	1/2	18.40	220-240/1/50
3070084	LF3070084	GX21TB	5/8	20.70	220-240/1/50
3070083	605212	GX23TB	5/8	23.20	220-240/1/50
3070085	LF3070085	GS26TB	3/4	25.90	220-240/1/50
3070086	605211	GS34TB	1	34.40	220-240/1/50

COMPRESSORS CUBIGEL R404a-R507 LBP



cubigel
compressors

REPA IT Code	REPA DE Code	Model	Motor power HP	Displacement cm ³	Power supply Volt/Ph/Hz
3070041	LF3070041	ML60FB	1/5	6.00	220-240/1/50
3070042	605207	ML80FB	1/4L	8.10	220-240/1/50
3070043	605176	ML90FB	1/4	8.80	220-240/1/50
3070366	LF3070366	MLY90LAa	1/3	9.10	220-240/1/50
3070374	605278	MLY12LAa	3/8	10.70	220-240/1/50
3070213	23835730	MPT12LA	3/8	12.10	220-240/1/50
3070032	605073	MP14FB	1/2	14.00	220-240/1/50
3070228	605307	MPT14LA	1/2	14.30	220-240/1/50
3070279	LF3070279	MPT16LA	1/2	16.10	220-240/1/50
3070033	605127	MX18FBa	5/8	18.40	220-240/1/50
3070034	605075	MX21FBa	3/4	20.70	220-240/1/50
3070072	605180	MX23FBa	1	23.20	220-240/1/50
3070035	LF3070035	MS26FB	1 1/4	25.90	220-240/1/50
3070066	605195	MS34FB	1 1/2	34.40	220-240/1/50

COMPRESSORS CUBIGEL R404a-R507 HMBP



cubigel
compressors

REPA IT Code	REPA DE Code	Model	Motor power HP	Displacement cm ³	Power supply Volt/Ph/Hz
3070161	605020	ML40TB	1/6	4.00	220-240/1/50
3070021	605068	ML45TB	1/5	4.50	220-240/1/50
3070022	605013	ML60TB	1/4	5.70	220-240/1/50
3070023	605014	ML80TB	1/3	7.60	220-240/1/50
3070024	605028	ML90TB	3/8	8.85	220-240/1/50
3070340	605310	MPT12RA	1/2	12.10	220-240/1/50
3070341	605067	MPT14RA	5/8	14.30	220-240/1/50
3070036	605072	MX18TBa	3/4	18.40	220-240/1/50
3070063	605093	MX21TBa	1	20.70	220-240/1/50
3070620	23158495	MS22TB	1	21.75	220-240/1/50
3070064	605071	MS26TB	1 1/4	25.90	220-240/1/50
3070065	LF3070065	MS34TB	1 1/2	34.40	220-240/1/50
3070621	23158497	MS34T3	1 5/8	34.42	400-440/3/50-60

Cubigel compressors

COMPRESSORS CUBIGEL R290 LBP



cubigel
compressors

REPA IT Code	REPA DE Code	Model	Motor power HP	Displacement cm ³	Power supply Volt/Ph/Hz
3070622	23158501	NBC41NA	1/8	4.10	220-240/1/50
3070401	605361	NUY45LAa	1/5	4.50	220-240/1/50
3070396	605355	NUT55CAc	1/5	5.50	220-240/1/50
3070398	605358	NUT60CAa	1/4	6.00	220-240/1/50
3070514	LF3070514	NUY80LA_A	1/3	8.10	220-240/1/50
3070404	605364	NLY90LAa	1/3	9.09	220-240/1/50
3070403	605363	NUG100NA	3/8	10.70	220-240/1/50
3070509	LF3070509	NUY120NA	3/8	12.50	220-240/1/50
3070407	605367	NPY14LAa	1/2	14.32	220-240/1/50
5120943	LF5134815	NPT16LA	1/2	16.15	220-240/1/50
5164642	LF5164642	NPT18LA	1/2	18.00	220-240/1/50
3070623	23158503	NX21FB	2/3	20.72	220-240/1/50-60
3070512	LF3070512	NX23FBa	7/8	23.20	220-240/1/50
3070513	LF3070513	NST26NA_T	3/4	25.93	220-240/1/50

COMPRESSORS CUBIGEL R290 HMBP



cubigel
compressors

REPA IT Code	REPA DE Code	Model	Motor power HP	Displacement cm ³	Power supply Volt/Ph/Hz
3070405	605365	NBC30RA	1/10	3.10	220-240/1/50
3070397	605356	NUY45RAa	1/5	4.50	220-240/1/50
3070406	605366	NUY60RAa	1/4	6.00	220-240/1/50
3070624	23158510	NUY70RAa	1/5	6.70	220-240/1/50
3070402	605362	NUY80RAa	1/3	8.10	220-240/1/50
3070625	23158511	NUY90RAa	3/8	8.90	220-240/1/50
3070508	LF3070508	NLY12RAa	3/8	10.70	220-240/1/50
3070400	605360	NPY12RAa	1/2	12.10	220-240/1/50
3070399	605357	NPT14RA	1/2	14.32	220-240/1/50
3070510	LF3070510	NPT16RA	2/3	16.10	220-240/1/50
5156331	LF5156331	NX18TBa	3/4	18.40	220-240/1/50
3070511	LF3070511	NX21TBa	7/8	20.72	220-240/1/50

COMPRESSORS CUBIGEL R600a LBP



REPA IT Code	REPA DE Code	Model	Motor power HP	Displacement cm ³	Power supply Volt/Ph/Hz
3070548	10568038	HLY40AA	1/12	4.00	220-240/1/50
3070549	10568039	HLY50AA	1/9	5.00	220-240/1/50
3070550	AT30FR322	HLY70AA	1/7	7.00	220-240/1/50
5154970	AT30FR320	HLY95AA	1/5+	9.50	220-240/1/50
5141771	AT30FR319	HLY12AA	1/4+	12.00	220-240/1/50
41626381	41626381	HYE131MHUA	1/3	14.00	220-240/1/50

Tecumseh compressors

COMPRESSORS TECUMSEH R134a HMBP



REPA IT Code	REPA DE Code	Model	Motor power HP	Displacement cm ³	Power supply Volt/Ph/Hz	Connection
3070233	LF3070233	THB4415YFZ	1/8	4.20	220-240/1/50	
41664800	41664800	TC4419Y-UZ1B	1/6	4.75	220-240/1/50-60	
3070235	LF3070235	THB4422YFZ	1/5	6.10	220-240/1/50	
3070247	605249	AE4425Y	1/5	6.70	220-240/1/50	
3070241	605173	AE4430Y	1/4	8.00	220-240/1/50	
3070242	605188	AE4440Y	1/3	10.30	220-240/1/50	
41676000	41676000	AE4450N	1/2	13.24	220-240/1/50	
3070244	605167	AE4456Y	1/2	14.50	220-240/1/50	
3070254	605098	AE4460Y	1/2	15.10	220-240/1/50	
3070145	605160	AJ4461N-FZ	1/2	18.30	220-240/1/50	with valve
3070313	LF3070313	AJ4476N	5/8	21.80	220-240/1/50	brazed
3070146	LF3070146	AJ4476N/R	5/8	21.80	220-240/1/50	with valve
2104055	605172	AJ4492N	3/4	26.00	220-240/1/50	brazed
3070147	605329	AJ4492N/R	3/4	26.00	220-240/1/50	with valve
41555751	41555751	AJ4511N-FZ	1	32.70	220-240/1/50	brazed
3070148	LF3070148	AJ4511N/R	1	32.70	220-240/1/50	with valve
3070149	LF3070149	TAJ4492Y/R	3/4	26.00	400/3/50	with valve
3070316	605332	AJ4511N-TZ	1	32.70	400/3/50	brazed
3070150	605273	AJ4511NR-TZ	1	32.70	400/3/50	with valve

COMPRESSORS TECUMSEH R134a HMBP - 2



REPA IT Code	REPA DE Code	Model	Motor power HP	Displacement cm ³	Power supply Volt/Ph/Hz	Connections
5077061	LF5077061	FH4518Y/S	1 1/2	53.20	220-240/1/50	brazed
2101211	LF2101211	FH4518Y/R	1 1/2	53.20	220-240/1/50	with valves
5077063	LF5077063	TFH4518Y/S	1 1/2	53.20	400/3/50	brazed
2102058	LF2102058	TFH4518Y/R	1 1/2	53.20	400/3/50	with valves
5077066	LF5077066	FH4525Y/S	2	74.25	220-240/1/50	brazed
5077067	LF5077067	FH4525Y/R	2	74.25	220-240/1/50	with valves
5077064	LF5077064	TFH4525Y/S	2	74.25	400/3/50	brazed
5077065	LF5077065	TFH4525Y/R	2	74.25	400/3/50	with valves
5077070	LF5077070	TAG4528Y/S	2 1/2	90.20	400/3/50	brazed
5077071	LF5077071	TAG4528Y/R	2 1/2	90.20	400/3/50	with valves
5077073	LF5077073	TAG4534Y/S	2 3/4	100.70	400/3/50	brazed
5077074	LF5077074	TAG4534Y/R	2 3/4	100.70	400/3/50	with valves
5077075	LF5077075	TAG4537Y/S	3	112.50	400/3/50	brazed
5077076	LF5077076	TAG4537Y/R	3	112.50	400/3/50	with valves
5077078	LF5077078	TAG4543Y/S	3 1/2	124.40	400/3/50	brazed
5077079	LF5077079	TAG4543Y/R	3 1/2	124.40	400/3/50	with valves

Tecumseh compressors

COMPRESSORS TECUMSEH R404a-R507 LBP



REPA IT Code	REPA DE Code	Model	Motor power HP	Displacement cm ³	Power supply Volt/Ph/Hz	Connection
3070245	LF3070245	AE2415Z	1/3	7.30	220-240/1/50	
3070382	LF3070382	AE1420Z	3/8	9.40	220-240/1/50	
3070240	605276	AE2425Z	1/2	12.00	220-240/1/50	
3070608	605157	AE2430Z	1	14.51	220-240/1/50	brazed
3070094	LF3070094	CAJ2428Z/R	1/2	15.20	220-240/1/50	with valve
3070319	LF3070319	AJ2432P	3/4	18.30	220-240/1/50	brazed
3070095	605238	AJ2432P/R	3/4	18.30	220-240/1/50	with valve
3070323	LF3070323	CAJ2440Z/S	1	22.80	220-240/1/50	brazed
3070096	LF3070096	CAJ2440Z/R	1	22.80	220-240/1/50	with valve
3070320	605306	AJ2446P	1 1/4	26.10	220-240/1/50	brazed
3070097	605134	AJ2446P/R	1 1/4	26.10	220-240/1/50	with valve
2101934	605320	AJ2464P	1 1/2	34.40	220-240/1/50	brazed
3070098	605136	AJ2464P/R	1 1/2	34.40	220-240/1/50	with valve
3070321	LF3070321	TAJ2446Z/S	1 1/4	26.10	400/3/50	brazed
41688081	41688081	AJ2446PR	1 1/4	26.15	400/3/50	with valve
3070322	605187	TAJ2464Z/S	1 1/2	34.40	400/3/50	brazed
3070100	605324	TAJ2464Z/R	1 1/2	34.40	400/3/50	with valve

COMPRESSORS TECUMSEH R404a-R507 LBP - 2



REPA IT Code	REPA DE Code	Model	Motor power HP	Displacement cm ³	Power supply Volt/Ph/Hz	Connections
5076960	LF5076960	FH2480Z/R	2	53.20	220-240/1/50	with valves
2102553	LF2102553	TFH2480Z/S	2	53.20	400/3/50	brazed
5076947	LF5076947	TFH2480Z/R	2	53.20	400/3/50	with valves
5077091	LF5077091	FH2511Z/S	3	74.25	220-240/1/50	brazed
5077092	LF5077092	FH2511Z/R	3	74.25	220-240/1/50	with valves
2101708	605335	TFH2511Z/S	3	74.25	400/3/50	brazed
2102773	LF2102773	TFH2511Z/R	3	74.25	400/3/50	with valves
5076948	LF5076948	TAG2516Z/S	4	112.50	400/3/50	brazed
5076950	LF5076950	AG2516P/R	4	112.50	400/3/50	with valves
5076951	LF5076951	TAG2522Z/S	5	134.80	400/3/50	brazed
5076952	LF5076952	TAG2522Z/R	5	134.80	400/3/50	with valves

Tecumseh compressors

COMPRESSORS TECUMSEH R404a-R507 HMBP



REPA IT Code	REPA DE Code	Model	Motor power HP	Displacement cm ³	Power supply Volt/Ph/Hz	Connection
3070248	605021	AE4425Z	1/5	4.20	220-240/1/50	
41670778	41670778	AE4430P	1/4	5.16	220-240/1/50	
3070249	605025	AE4430Z	1/4	5.20	220-240/1/50	
41676001	41676001	AE4440P	1/3	6.69	220-240/1/50	
3070250	605151	AE4440Z	1/3	6.70	220-240/1/50	
3070251	605023	AE4450Z	3/8	8.80	220-240/1/50	
3070252	605219	AE4460Z	1/2	10.30	220-240/1/50	
41676002	41676002	AE4460P	1/2	10.33	220-240/1/50	
3070253	LF3070253	AE4470Z	1/2	12.00	220-240/1/50	
3070317	605026	AJ4480P	5/8	15.20	220-240/1/50	brazed
3070130	605325	AJ4480P/R	5/8	15.20	220-240/1/50	with valve
3070135	LF3070135	TAJ9580Z/R	5/8	15.20	400/3/50	with valve
5039008	605032	AJ4510P	1	18.30	220-240/1/50	brazed
3070131	605327	AJ4510P/R	1	18.30	220-240/1/50	with valve
3070136	LF3070136	TAJ9510Z/R	1	18.30	400/3/50	with valve
5010941	605070	AJ4513P-FZ	1	24.20	220-240/1/50	brazed
3070132	LF3070132	AJ4513P/R	1	24.20	220-240/1/50	with valve
3070137	605236	TAJ9513Z/R	1	24.20	400/3/50	with valve
2101715	605027	AJ4517P	1 1/5	25.90	220-240/1/50	brazed
3070133	605328	AJ4517P/R	1 1/5	25.90	220-240/1/50	with valve
3070138	LF3070138	TAJ4517Z/R	1 1/5	25.90	400/3/50	with valve
5021390	605065	AJ4519P	1 1/2	34.40	220-240/1/50	brazed
3070134	605326	AJ4519P/R	1 1/2	34.40	220-240/1/50	with valve
5068808	LF5068808	TAJ4519Z/S	1 1/2	34.40	400/3/50	brazed
3070139	605277	TAJ4519Z/R	1 1/2	34.40	400/3/50	with valve

Tecumseh compressors

COMPRESSORS TECUMSEH R404a-R507 HMBP - 2



REPA IT Code	REPA DE Code	Model	Motor power HP	Displacement cm ³	Power supply Volt/Ph/Hz	Connections
5019103	LF5019103	FH4522Z/S	1 4/5	39.95	220-240/1/50	brazed
3070312	LF3070312	FH4522Z/R	1 4/5	39.95	220-240/1/50	with valves
5077022	LF5077022	TFH4522Z/S	1 4/5	39.95	400/3/50	brazed
5077017	LF5077017	TFH4522Z/R	1 4/5	39.95	400/3/50	with valves
5077025	LF5077025	FH4524/S	2	43.50	220-240/1/50	brazed
5077026	LF5077026	FH4524/R	2	43.50	220-240/1/50	with valves
5077027	LF5077027	TFH4524Z/S	2	43.50	400/3/50	brazed
2102343	LF2102343	TFH4524Z/R	2	43.50	400/3/50	with valves
5077086	LF5077086	FH4531Z/S	2 1/2	56.65	220-240/1/50	brazed
5077028	605037	FH4532Z/S	2 1/2	56.65	400/3/50	brazed
5077030	LF5077030	TFH4531Z/R	2 1/2	56.65	400/3/50	with valves
5077089	605042	FH4538Z/S	3	63.00	220-240/1/50	brazed
5077033	LF5077033	TFH4540Z/S	3	74.25	400/3/50	brazed
5077034	LF5077034	FH4538Z-XG1A	3	74.25	400/3/50	with valves
5077031	LF5077031	TAG4546Z/S	4	90.20	400/3/50	brazed
5077035	LF5077035	TAG4546Z/R	4	90.20	400/3/50	with valves
5077036	LF5077036	TAG4553Z/S	4 1/2	100.70	400/3/50	brazed
5077037	LF5077037	TAG4553Z/R	4 1/2	100.70	400/3/50	with valves
5077043	LF5077043	TAG4561Z/R	5	112.50	400/3/50	with valves
5077044	LF5077044	TAG4568Z/S	6	124.40	400/3/50	brazed
5077045	LF5077045	TAG4568Z/R	6	124.40	400/3/50	with valves
5077046	LF5077046	TAG4573Z/S	6 1/2	134.80	400/3/50	brazed
5077051	LF5077051	TAG4573Z/R	6 1/2	134.80	400/3/50	with valves

COMPRESSORS TECUMSEH R290 HMBP



REPA IT Code	REPA DE Code	Model	Motor power HP	Displacement cm ³	Power supply Volt/Ph/Hz
3070517	LF3070517	AE4425U	1/5	5.02	220-240/1/50
3070518	LF3070518	AE4430U	1/4	6.12	220-240/1/50
3070519	LF3070519	AE4440U	1/3	8.02	220-240/1/50
3070520	LF3070520	AE4450U	3/8	10.33	220-240/1/50
3070521	LF3070521	AE4460U	1/2	12.01	220-240/1/50

Tecumseh compressors

COMPRESSORS TECUMSEH R290 LBP



REPA IT Code	REPA DE Code	Model	Motor power HP	Displacement cm ³	Power supply Volt/Ph/Hz
3070522	LF3070522	AE2410U	1/5	6.12	220-240/1/50
3070524	LF3070524	AE2415U	1/3	8.85	220-240/1/50
3070523	LF3070523	AE2420U	1/2	10.96	220-240/1/50

Danfoss Maneurop compressors

COMPRESSORS DANFOSS MANEUROP



REPA IT Code	REPA DE Code	Model	Power supply Volt/Ph/Hz	Volume
3070555	LF3070555	MTZ18-4VM	380/460V /3/ 50-60Hz	30.23 cm ³
3070556	LF3070556	MTZ22-4VM	380/460V /3/ 50-60Hz	38.12 cm ³
3070557	LF3070557	MTZ28-4VM	380/460V /3/ 50-60Hz	48.06 cm ³
3070558	LF3070558	MTZ32-4VM	380/460V /3/ 50-60Hz	53.86 cm ³
3070559	LF3070559	MTZ36-4VM	380/460V /3/ 50-60Hz	60.47 cm ³
3070560	LF3070560	MTZ40-4VM	380/460V /3/ 50-60Hz	67.89 cm ³
3070561	LF3070561	MTZ44-4VM	380/460V /3/ 50-60Hz	76.22 cm ³
3070562	LF3070562	MTZ50-4VM	380/460V /3/ 50-60Hz	85.64 cm ³
3070563	LF3070563	MTZ56-4VM	380/460V /3/ 50-60Hz	96.13 cm ³
3070564	LF3070564	MTZ64-4VM	380/460V /3/ 50-60Hz	107.71 cm ³
3070565	LF3070565	MTZ72-4VM	380/460V /3/ 50-60Hz	120.94 cm ³
3070566	LF3070566	MTZ80-4VM	380/460V /3/ 50-60Hz	135.78 cm ³
5191548	LF5191548	MTZ100-4VM	380/460V /3/ 50-60Hz	171.26 cm ³
3070567	LF3070567	MTZ125-4VM	380/460V /3/ 50-60Hz	215.44 cm ³
3070568	LF3070568	MTZ144-4VM	380/460V /3/ 50-60Hz	241.87 cm ³
3070569	LF3070569	MTZ160-4VM	380/460V /3/ 50-60Hz	271.55 cm ³

Compressors accessories

UNIVERSAL ANTI-VIBRATION FEET FOR COMPRESSORS



REPA IT Code	REPA DE Code	Size	Load	ø Tapered thread
3313136	LF3313136	Ø40mm X h40mm	max 100kg	M8 - 8mm

ELECTROLYTIC CAPACITORS FOR SINGLE-PHASE MOTOR STARTING



REPA IT Code	REPA DE Code	Capacity μF	Volt	ø mm	Height mm
3068101	365095	43÷52	330V	36.5	68.5
3068102	365153	47÷56	330V	45.5	84
3068104	365057	53÷64	330V	45.5	84
3068070	365094	64÷77	330V	45.5	84
3068103	365096	88÷106	330V	45.5	84
3068067	365111	108÷130	330V	52	105
3068068	365101	124÷149	330V	52	105
3068069	LF3068069	145÷174	330V	52	105

RUNNING CAPACITORS



REPA IT Code	REPA DE Code	Capacity μF	ø x H mm
3068034	LF3068034	10	40x72
3068039	LF3068039	12	40x72
3068040	LF3068040	15	40x98
3068035	LF3068035	20	40x98
3068036	LF3068036	25	45x98
3068037	LF3068037	30	45x122
3068038	365097	35	45x122

Scroll compressors

COMPRESSORS SCROLL COPELAND



REPA IT Code	REPA DE Code	Model	Power supply Volt/Ph/Hz	Lubricating oils	Flow rate
3070432	LF3070432	ZR18K3E PFJ 522	220/240 V 50/60 Hz	POE 32	4.39 m ³ /h
3070433	LF3070433	ZR22K3E PFJ 522	220/240 V 50/60 Hz	POE 32	5.34 m ³ /h
3070434	LF3070434	ZR28K3E PFJ 522	220/240 V 50/60 Hz	POE 32	6.83 m ³ /h
3070435	LF3070435	ZR34K3E PFJ 522	220/240 V 50/60 Hz	POE 32	8.03 m ³ /h
3070436	LF3070436	ZR34K3E TFD 522	400 V / 3ph - 50/60 Hz	POE 32	8.03 m ³ /h
3070438	LF3070438	ZR40K3E TFD 522	400 V / 3 ph - 50/60 Hz	POE 32	4.39 m ³ /h
3070437	LF3070437	ZR40K3E PFJ 522	220/240 V 50/60 Hz	POE 32	9.43 m ³ /h

COMPRESSORS PANASONIC



REPA IT Code	REPA DE Code	Model	Power supply Volt/Ph/Hz
3070583	LF3070583	C-SBN303H8G	380-415/3/50
3070584	LF3070584	C-SBN353H8G	380-415/3/50
3070585	LF3070585	C-SBN373H8G	380-415/3/50
3070586	LF3070586	C-SBS235H38B	380-415/3/50
3070587	LF3070587	C-SCN603H8K	380-415/3/50
3070588	LF3070588	C-SCN753H8K	380-415/3/50
3070589	LF3070589	C-SCN903H8K	380-415/3/50
3070590	LF3070590	C-SBN303H8H	380-415/3/50
3070591	LF3070591	C-SBN523H8H	380-415/3/50
3070592	LF3070592	C-SCP270H38B	380-415/3/50
3070593	LF3070593	C-SCP510H38B	380-415/3/50

Semi-hermetic compressors

SEMI-HERMETIC COMPRESSORS DORIN



REPA IT Code	REPA DE Code	Model	Power supply Volt/Ph/Hz	Lubricating oils	Flow rate
3070526	LF3070526	H51CS	220/240V /3/ 50Hz 380/420V /3/ 50Hz	POE 32	4.42m ³ /h
3070528	LF3070528	H80CC	220/240V /3/ 50Hz 380/420V /3/ 50Hz	POE 32	4.42m ³ /h
3070529	LF3070529	H80CS	220/240V /3/ 50Hz 380/420V /3/ 50Hz	POE 32	5.37m ³ /h
3070441	LF3070441	H101CC	220/240V /3/ 50Hz 380/420V /3/ 50Hz	POE 32	5.37m ³ /h
3070442	LF3070442	H101CS	220/240V /3/ 50Hz 380/420V /3/ 50Hz	POE 32	6.71m ³ /h
3070443	LF3070443	H151CC	220/240V /3/ 50Hz 380/420V /3/ 50Hz	POE 32	6.71m ³ /h
3070444	LF3070444	H151CS	220/240V /3/ 50Hz 380/420V /3/ 50Hz	POE 32	7.50m ³ /h
3070445	LF3070445	H181CC	220/240V /3/ 50Hz 380/420V /3/ 50Hz	POE 32	7.50m ³ /h
3070446	LF3070446	H181CS	220/240V /3/ 50Hz 380/420V /3/ 50Hz	POE 32	9.16m ³ /h
3070447	LF3070447	H201CC	220/240V /3/ 50Hz 380/420V /3/ 50Hz	POE 32	9.16m ³ /h
3070449	LF3070449	H201CS	220/240V /3/ 50Hz 380/420V /3/ 50Hz	POE 32	9.88m ³ /h

SPARE PARTS FOR SEMI-HERMETIC COMPRESSORS DORIN



REPA IT Code	REPA DE Code	Description
5238764	LF5238764	KIT GASKET H11 D.38
5238766	LF5238766	VALVE PLATE KIT H11 D38

Semi-hermetic compressors

SEMI-HERMETIC COMPRESSORS FRASCOLD



REPA IT Code	REPA DE Code	Model	Power supply Volt/Ph/Hz	Volume
3070570	LF3070570	A05-4Y	220/240V /3/ 50Hz 380/420V /3/ 50Hz	3.95m ³ /h
3070571	LF3070571	A07-5Y	220/240V /3/ 50Hz 380/420V /3/ 50Hz	4.93m ³ /h
3070572	LF3070572	A1-6Y	220/240V /3/ 50Hz 380/420V /3/ 50Hz	5.47m ³ /h
3070573	LF3070573	A1-7Y	220/240V /3/ 50Hz 380/420V /3/ 50Hz	6.91m ³ /h
3070574	LF3070574	A1.5-7Y	220/240V /3/ 50Hz 380/420V /3/ 50Hz	6.91m ³ /h
3070575	LF3070575	A1.5-8Y	220/240V /3/ 50Hz 380/420V /3/ 50Hz	7.65m ³ /h
3070576	LF3070576	B1.5-9.1Y	220/240V /3/ 50Hz 380/420V /3/ 50Hz	9.00m ³ /h
3070577	LF3070577	B2-10.1Y	220/240V /3/ 50Hz 380/420V /3/ 50Hz	9.88m ³ /h
3070578	LF3070578	D2-13.1Y	220/240V /3/ 50Hz 380/420V /3/ 50Hz	13.20m ³ /h
3070579	LF3070579	D2-15.1Y	220/240V /3/ 50Hz 380/420V /3/ 50Hz	15.40m ³ /h

REFRIGERATION UNITS

SECCP

embraco

cubigel
compressors

TECO®

MTH

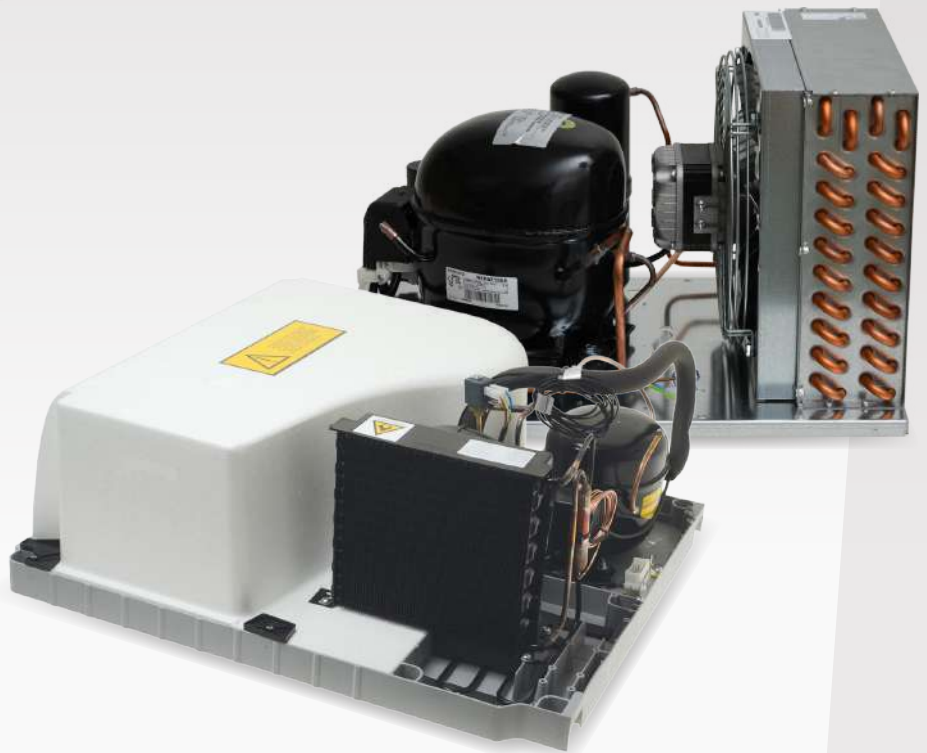

Condensing units and monoblock systems are compact assemblies that integrate the key components of the refrigeration circuit. A condensing unit functions as a complete subsystem, typically including a compressor, condenser and, when present, a liquid receiver. It is designed to deliver the refrigeration capacity required by a cabinet or cold room by supplying refrigerant to the evaporator.

Monoblock units extend this concept by incorporating the evaporator into a single, ready-to-install package, simplifying both installation and maintenance. These solutions provide reliable and standardized refrigeration performance, making them well-suited for commercial and professional applications.

More value
for you

- 1 One of the largest selections **always in stock**.
- 2 A broad **portfolio** from multiple leading manufacturers.
- 3 Monoblocks available and ready for **immediate delivery**.
- 4 Plug & play solutions for **fast and easy installation**.

Condensing units

CONDENSING UNITS TECUMSEH BT R452/R404 LBP - THERMOSTATIC VALVE



REPA IT Code	REPA DE Code	Compressors	Motor power HP	Displacement cm ³	Power supply Volt/Ph/Hz	Dimensions mm LxDxH
3058075	LF3058075	AE2415Z	1/4	6.69	230 / 1 / 50	310x470x270
3058076	LF3058076	AE2425Z	1/2	12.10	230 / 1 / 50	330x500x235
3058077	LF3058077	CAJ2432Z	3/4	18.30	230 / 1 / 50	390x490x345
3058078	LF3058078	CAJ2440Z	1.1	22.50	230 / 1 / 50	390x490x345
3058079	LF3058079	CAJ2464Z	1.5	34.50	230 / 1 / 50	550x410x370
3058080	LF3058080	FH2480Z XC	2	54.30	230 / 1 / 50	520x580x430
3058081	LF3058081	TAG2513Z	3.7	100.70	400 / 3 / 50	750x780x540

CONDENSING UNITS TECUMSEH TN R452/R404 HMBP - THERMOSTATIC VALVE



REPA IT Code	REPA DE Code	Compressors	Motor power HP	Displacement cm ³	Power supply Volt/Ph/Hz	Dimensions mm LxDxH
3058086	LF3058086	AE4450Z	1/3	8.85	230 / 1 / 50	310x470x270
3058087	LF3058087	AE4460Z	1/2	10.33	230 / 1 / 50	330x500x295
3058088	LF3058088	CAJ9480Z	3/4	15.20	230 / 1 / 50	390x490x345
3058089	LF3058089	TAJ9510Z	1	18.30	400 / 3 / 50	390x490x345
3058090	LF3058090	CAJ4517Z	1 1/4	25.95	230 / 1 / 50	550x410x370

CONDENSING UNITS TECUMSEH TN R452/R404 HMBP - CAPILLARY



REPA IT Code	REPA DE Code	Compressors	Motor power HP	Displacement cm ³	Power supply Volt/Ph/Hz	Dimensions mm LxDxH
3058082	LF3058082	AE4425Z	1/6	4.24	230 / 1 / 50	310x470x270
3058083	LF3058083	AE4430Z	1/4	5.16	230 / 1 / 50	310x470x270
3058084	LF3058084	AE4450Z	1/3	8.85	230 / 1 / 50	310x470x270
3058085	LF3058085	AE4460Z	1/2	10.33	230 / 1 / 50	330x500x295

Condensing units

CONDENSING UNITS TECUMSEH TN R134 HMBP - THERMOSTATIC VALVE



REPA IT Code	REPA DE Code	Compressors	Motor power HP	Displacement cm ³	Power supply Volt/Ph/Hz	Dimensions mm LxDxH
3058072	LF3058072	CAJ4476Y	5/8	22.80	230 / 1 / 50	390x490x345
3058073	LF3058073	CAJ4492Y	3/4	25.90	230 / 1 / 50	390x490x345
3058074	LF3058074	TFH4525Y XG	2	63.00	400 / 3 / 50	520x580x430

CONDENSING UNITS TECUMSEH TN R134 HMBP - CAPILLARY



REPA IT Code	REPA DE Code	Compressors	Motor power HP	Displacement cm ³	Power supply Volt/Ph/Hz	Dimensions mm LxDxH
3058068	LF3058068	THB4419Y	1/6	5.00	230 / 1 / 50	300x420x220
3058069	LF3058069	AE4440Y	1/3	10.33	230 / 1 / 50	310x470x270
3058070	LF3058070	AE4450Y	3/8+	13.24	230 / 1 / 50	310x470x270
3058071	LF3058071	AE4460Y	1/2+	15.09	230 / 1 / 50	330x500x295

HERMETIC AIR-COOLED CONDENSING UNITS R134a HMBP - CAPILLARY APPLICATION WITH TAPS



embraco

REPA IT Code	REPA DE Code	Compressors	Motor power HP	Displacement cm ³	Power supply Volt/Ph/Hz	Dimensions mm LxDxH
3123042	LF3123042	EMT6144Z	1/5	5.20	230/1/50	300x420x276
3123018	LF3123018	EMT6160Z	1/4L	6.76	230/1/50	300x460x275
3123005	LF3123005	EMT6170Z	1/4	7.69	230/1/50	300x460x276
3123054	LF3123054	NEK6187Z	1/3	10.00	230/1/50	300x460x276
3123077	LF3123077	NEU6212Z	1/2L	14.30	230/1/50	300x480x276
3123144	LF3123144	NEU6214Z	1/2	16.80	230/1/50	300x510x276

HERMETIC AIR-COOLED CONDENSING UNITS R134a HMBP - THERMOSTATIC VALVE APPLICATION WITH TAPS



embraco

REPA IT Code	REPA DE Code	Compressors	Motor power HP	Displacement cm ³	Power supply Volt/Ph/Hz	Dimensions mm LxDxH
3123055	LF3123055	EMT6144Z	1/5	5.20	230/1/50	300x460x276
3123056	LF3123056	EMT6160Z	1/4L	6.76	230/1/50	300x460x276
3123057	LF3123057	EMT6170Z	1/4	7.69	230/1/50	300x460x276
3123058	LF3123058	NEK6187Z	1/3	10.00	230/1/50	300x480x276
3123076	LF3123076	NEU6212Z	1/2L	14.30	230/1/50	300x510x276
3123059	LF3123059	NEU6214Z	1/2	16.80	230/1/50	300x540x276
3123049	LF3123049	NT6215Z	5/8	17.39	230/1/50	390x480x350
3123030	LF3123030	NT6220Z	3/4	26.20	230/1/50	390x510x350
3123031	LF3123031	NJ6226Z	1	34.37	230/1/50	390x540x350
3123027	LF3123027	NJ6226ZX	1	34.37	400/3/50	390x540x350

HERMETIC AIR-COOLED CONDENSING UNITS R404a/R507 HMBP - CAPILLARY APPLICATION WITH TAPS



embraco

REPA IT Code	REPA DE Code	Compressors	Motor power HP	Displacement cm ³	Power supply Volt/Ph/Hz	Dimensions mm LxDxH
3123145	LF3123145	EMT6144GK	1/6	3.97	230/1/50	300x420x276
3123146	LF3123146	EMT6152GK	1/5	4.50	230/1/50	300x420x276
3123147	LF3123147	EMT6165GK	1/4L	5.20	230/1/50	300x460x276
3123148	LF3123148	NEK6181GK	1/3L	7.28	230/1/50	300x460x276
3123149	LF3123149	NEU6212GK	1/3	8.78	230/1/50	300x480x276

Condensing units

HERMETIC AIR-COOLED CONDENSING UNITS R404a/R507 HMBP - THERMOSTATIC VALVE APPLICATION WITH TAPS



embraco

REPA IT Code	REPA DE Code	Compressors	Motor power HP	Displacement cm ³	Power supply Volt/Ph/Hz	Dimensions mm LxDxH
3123053	LF3123053	EMT6144GK	1/6	3.97	230/1/50	300x460x276
3123016	LF3123016	EMT6152GK	1/5	4.50	230/1/50	300x460x276
3123029	LF3123029	EMT6165GK	1/4L	5.20	230/1/50	300x460x276
3123025	LF3123025	NEK6181GK	1/4	7.38	230/1/50	300x460x276
3123017	LF3123017	NEU6212GK	1/3	8.78	230/1/50	300x510x276
3123043	LF3123043	NEU6215GK	1/2	12.12	230/1/50	346x450x297
3123028	LF3123028	NEK6217GK	5/8	14.30	230/1/50	390x510x350
3123044	LF3123044	NT6222GK	3/4	17.40	230/1/50	390x510x350
3058005	LF3058005	NT6224GK	1	20.44	230/1/50	390x510x350
3123050	LF3123050	NT6226GK	1	22.40	230/1/50	390x540x350
3123033	LF3123033	NT6226GK	1	22.40	230/1/50	650x480x280
3123045	LF3123045	NJ9232GK	1 1/5	26.20	230/1/50	450x540x375
3123034	LF3123034	NJ9232GK	1 1/5	26.20	230/1/50	650x480x330
3123036	LF3123036	NJ9232GS	1 1/5	26.20	400/3/50	491x787x328
3123041	LF3123041	NJ9238GK	1 1/2	32.70	230/1/50	520x580x440
3123035	LF3123035	NJ9238GK	1 1/2	32.70	230/1/50	461x787x331
3123037	LF3123037	NJ9238GS	1 1/2	32.70	400/3/50	650x480x330

HERMETIC AIR-COOLED CONDENSING UNITS R404a/R507 LBP - CAPILLARY APPLICATION WITH TAPS



embraco

REPA IT Code	REPA DE Code	Compressors	Motor power HP	Displacement cm ³	Power supply Volt/Ph/Hz	Dimensions mm LxDxH
3123150	LF3123150	NEU2140GK	1/3	8.78	230/1/50	300x480x276
3123151	LF3123151	NEU2155GK	1/2	12.12	230/1/50	300x480x276
3123152	LF3123152	NEK2168GK	3/4	14.30	230/1/50	300x480x276
3123153	LF3123153	NT2178GK	1	17.40	230/1/50	300x480x276

HERMETIC AIR-COOLED CONDENSING UNITS R404a/R507 LBP - THERMOSTATIC VALVE APPLICATION WITH TAPS



embraco

REPA IT Code	REPA DE Code	Compressors	Motor power HP	Displacement cm ³	Power supply Volt/Ph/Hz	Dimensions mm LxDxH
3123051	LF3123051	NEK2130GK	1/4	7.40	230/1/50	300x460x276
3123026	LF3123026	NEU2140GK	1/3	8.78	230/1/50	300x510x276
3123052	LF3123052	NEU2155GK	1/2	12.11	230/1/50	300x540x276
3123048	LF3123048	NEU2168GK	3/4	14.28	230/1/50	390x480x350
3123032	LF3123032	NT2178GK	1 1/5	17.40	230/1/50	494x340x296
3058004	LF3058004	NT2180GK	1	20.44	230/1/50	390x480x350
3123046	LF3123046	NJ2192GK	1 1/5	26.00	230/1/50	390x510x350
3123040	LF3123040	NJ2212GK	1 1/2	34.37	230/1/50	481x409x324
3123038	LF3123038	NJ2212GK	1 1/2	34.37	230/1/50	650x480x330
3123047	LF3123047	NJ2212GS	1 1/2	34.37	400/3/50	450x540x375
3123039	LF3123039	NJ2212GS	1 1/2	34.37	400/3/50	650x480x330

AIR-COOLED CONDENSING UNITS SECOP R134a HMBP - CAPILLARY APPLICATION



SECOP

REPA IT Code	REPA DE Code	Compressors	HP	Displacement cm ³	Power supply Volt/Ph/Hz	Dimensions mm LxDxH
3058040	LF3058040	TL5G	1/6	5.10	187-254/1/50-60	380x300x230
3058043	LF3058043	FR7.5G	1/5	6.90	187-254/1/50-60	380x300x230
3058045	LF3058045	FR8.5G	1/4L	7.95	187-254/1/50-60	380x300x230
3058049	LF3058049	NL11MF	1/3	11.10	187-254/1/50	450x350x300
3058050	LF3058050	FR11G	1/3L	11.20	187-254/1/50	380x300x275
3058053	LF3058053	SC15G	3/8	15.30	187-254/1/50-60	450x350x300
3058052	LF3058052	SC15MFX	3/8	15.30	198-254/1/50	450x350x300
3058054	LF3058054	SC18MFX	1/2	17.70	187-254/1/50-60	450x350x300
3058056	LF3058056	SC21G	5/8	21.00	187-254/1/50-60	490x390x350

Condensing units

AIR-COOLED CONDENSING UNITS SECOP R134a HMBP - THERMOSTATIC VALVE APPLICATION



SECOP

REPA IT Code	REPA DE Code	Compressors	HP	Displacement cm ³	Power supply Volt/Ph/Hz	Dimensions mm LxDxH
3058057	605286	NL10MF	1/3L	10.10	187-254/1/50-60	450x350x300
3058060	605295	SC18MFX	1/2	17.70	198-254/1/50	450x350x300
3058061	605296	SC21MFX	5/8	21.00	198-254/1/50	490x390x350
3058062	LF3058062	GS26MFX	3/4	26.30	198-254/1/50	490x390x350
3058063	LF3058063	GS34MFX	1	33.80	198-254/1/50	530x430x375

AIR-COOLED CONDENSING UNITS SECOP R404a/R507 HMBP - CAPILLARY APPLICATION



SECOP

REPA IT Code	REPA DE Code	Compressors	HP	Displacement cm ³	Power supply Volt/Ph/Hz	Dimensions mm LxDxH
3058013	LF3058013	NL6.1MLX	1/5	6.10	187-254/1/50-60	380x300x275
3058015	LF3058015	NF7MLX	1/4	7.30	187-254/1/50-60	450x350x300
3058016	LF3058016	SC10MLX	1/3	10.30	187-254/1/50-60	450x350x300
3058017	LF3058017	SC12MLX	1/2	12.90	187-254/1/50-60	450x350x300
3058018	LF3058018	SC15MLX	5/8	15.30	198-254/1/50	490x390x350
3058019	LF3058019	SC18MLX	3/4	17.70	198-254/1/50	530x430x375

AIR-COOLED CONDENSING UNITS SECOP R404a/R507 HMBP - THERMOSTATIC VALVE APPLICATION



SECOP

REPA IT Code	REPA DE Code	Compressors	HP	Displacement cm ³	Power supply Volt/Ph/Hz	Dimensions mm LxDxH
3058020	605297	NF7MLX	1/4	7.30	230/1/50	450x350x300
3058021	605298	SC10MLX	1/3	10.30	230/1/50	450x350x300
3058022	605299	SC12MLX	1/2	12.90	230/1/50	450X350X300
3058023	605300	SC15MLX	5/8	15.30	230/1/50	490x390x350
3058024	605301	SC18MLX	3/4	17.70	230/1/50	530x430x375
3058025	LF3058025	GS21MLX	1	21.20	230/1/50	530x430x375
3058026	LF3058026	GS26MLX	1 1/5	26.30	230/1/50	530x430x375
3058027	LF3058027	GS34MLX	1 1/2	33.80	230/1/50	530x530x430

AIR-COOLED CONDENSING UNITS SECOP R404a/R507 LBP - CAPILLARY APPLICATION



SECOP

REPA IT Code	REPA DE Code	Compressors	HP	Displacement cm ³	Power supply Volt/Ph/Hz	Dimensions mm LxDxH
3058028	LF3058028	TL4CL	1/6	3.90	198-254/1/50	380x300x230
3058029	LF3058029	NL7CLX	1/5	7.30	198-254/1/50	380x300x275
3058030	LF3058030	NL8.4CLX	1/4	8.40	198-254/1/50	380x300x275
3058031	LF3058931	SC12CLX.2	3/8	12.30	198-254/1/50-60	450x350x300
3058032	LF3058032	SC15CLX.2	1/2	15.30	198-254/1/50-60	450x350x300
3058033	LF3058033	SC18CL	5/8	17.70	198-254/1/50	490x390x350

Condensing units

AIR-COOLED CONDENSING UNITS SECOP R404a/R507 LBP - THERMOSTATIC VALVE APPLICATION



SECOP

REPA IT Code	REPA DE Code	Compressors	HP	Displacement cm ³	Power supply Volt/Ph/Hz	Dimensions mm LxDxH
3058034	605288	NL8.4CLX	1/4	8.40	198-254/1/50	450x350x275
3058035	605289	SC12CLX.2	3/8	12.30	198-254/1/50-60	450x350x300
3058036	605290	SC15CLX.2	1/2	15.30	198-254/1/50	450x350x300
3058037	605291	SC21CL	3/4	21.20	198-254/1/50	490x390x350
3058038	LF3058038	GS26CLX	1 1/5	26.30	198-254/1/50	530x430x375
3058039	LF3058039	GS34CLX	1 2/3	33.80	198-254/1/50	530x430x375

CONDENSING UNITS CUBIGEL TN R134 HMBP - CAPILLARY



cubigel
compressors

REPA IT Code	REPA DE Code	Compressors	Motor power HP	Displacement cm ³	Power supply Volt/Ph/Hz
3058134	LF3058134	GL60TB	1/5	5.70	230V / 1 / 50

CONDENSING UNITS CUBIGEL TN R134 HMBP - THERMOSTATIC VALVE



cubigel
compressors

REPA IT Code	REPA DE Code	Compressors	Motor power HP	Displacement cm ³	Power supply Volt/Ph/Hz
3058145	LF3058145	GL60TB	1/5	5.70	230V / 1 / 50
3058146	LF3058146	GLY12RA	3/8	10.70	230V / 1 / 50

CONDENSING UNITS CUBIGEL TN R404/R507 HMBP - CAPILLARY



cubigel
compressors

REPA IT Code	REPA DE Code	Compressors	Motor power HP	Displacement cm ³	Power supply Volt/Ph/Hz
3058147	LF3058147	ML45TB	1/5	4.56	230V / 1 / 50
3058148	LF3058148	ML80TB	1/3	7.57	230V / 1 / 50

CONDENSING UNITS CUBIGEL TN R404/R507 HMBP - THERMOSTATIC VALVE



cubigel
compressors

REPA IT Code	REPA DE Code	Compressors	Motor power HP	Displacement cm ³	Power supply Volt/Ph/Hz
3058149	LF3058149	ML45TB	1/5	4.56	230V / 1 / 50
3058150	LF3058150	ML90TB	3/8	8.85	230V / 1 / 50

CONDENSING UNITS CUBIGEL BT R404/R507 LBP - CAPILLARY

cubigel
compressors

REPA IT Code	REPA DE Code	Compressors	Motor power HP	Displacement cm ³	Power supply Volt/Ph/Hz
3058151	LF3058151	MLY90LAa	1/3	9.09	230V / 1 / 50

CONDENSING UNITS CUBIGEL BT R404/R507 LBP - THERMOSTATIC VALVE



cubigel
compressors

REPA IT Code	REPA DE Code	Compressors	Motor power HP	Displacement cm ³	Power supply Volt/Ph/Hz
3058152	LF3058152	MLY90LAa	1/3	9.09	230V / 1 / 50
3058153	LF3058153	MPT14LA	1/2	14.32	230V / 1 / 50

Condensing units

CONDENSING UNITS TN R290 MHBP - CAPILLARY



embraco

REPA IT Code	REPA DE Code	Compressors	Motor power HP	Displacement cm ³	Power supply Volt/Ph/Hz	Dimensions mm LxDxH
3058121	LF3058121	EMT6144U	1/5	4.50	230 /1 / 50	400x300x270
3058122	LF3058122	EMT6165U	1/4	5.96	230 /1 / 50	400x300x270
3058123	LF3058123	NEK6210U	1/3	8.77	230 /1 / 50	450x340x300
41496463	41496463	NEU6214U	1/2	12.12	230 /1 / 50	470x395x319
3058124	LF3058124	NEK6217U	1/2	14.28	230 /1 / 50	500x400x350
3058125	LF3058125	NT6220U	3/4	17.40	230 /1 / 50	500x400x350

CONDENSING UNITS EMBRACO BT R290 LBP - CAPILLARY



embraco

REPA IT Code	REPA DE Code	Compressors	Motor power HP	Displacement cm ³	Power supply Volt/Ph/Hz	Dimensions mm LxDxH
3058126	LF3058126	EMT2117U	1/5	4.50	230 /1 / 50	400x300x270
3058127	LF3058127	EMT2121U	1/4	5.57	230 /1 / 50	400x300x270
3058128	LF3058128	EMT2130U	1/3	6.74	230 /1 / 50	400x300x270
3058129	LF3058129	NEK2134U	1/2	10.00	230 /1 / 50	450x340x300
41496464	41496464	NEU2155U	3/4	13.54	230 /1 / 50	465x340x308
41496465	41496465	NEU2170UA	3/4	16.80	230 /1 / 50	465x340x308
3058130	LF3058130	NT2170U	3/4	20.44	230 /1 / 50	500x400x350
3058131	LF3058131	NT2180U	1	22.40	230 /1 / 50	500x400x350
3058132	LF3058132	NT2210U	1	27.80	230 /1 / 50	500x400x350
41496466	41496466	NTX2213U	1 1/2	33.42	230 /1 / 50	470x395x319

WATER CONDENSING UNITS EMBRACO BT R404/R452 LBP - VALVE



embraco

REPA IT Code	REPA DE Code	Compressors	Motor power HP	Displacement cm ³	Power supply Volt/Ph/Hz	Dimensions mm LxDxH
3058116	LF3058116	EMT 2121 GK	1/3	5.19	230 /1 / 50	500x340x270
3058117	LF3058117	NEK 2134 GK	1/2	8.77	230 /1 / 50	500x340x300
3058118	LF3058118	NEK 2168 GK	3/4	14.28	230 /1 / 50	540x400x350
3058119	LF3058119	NT 2180 GK	1	20.44	230 /1 / 50	540x400x350
3058111	LF3058111	NT 2192 GK	1 1/4	22.37	230 /1 / 50	540x400x350

Condensing units

SILENCED CONDENSING UNITS TECUMSEH TN R404/R452 HBP - VALVE



REPA IT Code	REPA DE Code	Compressors	Motor power HP	Displacement cm ³	Power supply Volt/Ph/Hz	Dimensions mm LxDxH
3058133	LF3058133	AE4460Z	1/2	10.33	230 /1 / 50	850x360x770
3058135	LF3058135	CAJ9480Z	3/4	15.20	230 /1 / 50	850x360x770
3058136	LF3058136	CAJ9510Z	1	18.30	230 /1 / 50	850x360x770
3058137	LF3058137	CAJ4519Z	1 1/2	34.50	230 /1 / 50	850x360x770
3058138	LF3058138	FH4524Z XC	2	43.30	230 /1 / 50	1200x400x810

SILENCED CONDENSING UNITS TECUMSEH BT R404/R452 LBP - VALVE



REPA IT Code	REPA DE Code	Compressors	Motor power HP	Displacement cm ³	Power supply Volt/Ph/Hz	Dimensions mm LxDxH
3058139	LF3058139	CAJ2432Z	3/4	18.30	230 /1 / 50	850x360x770
3058140	LF3058140	CAJ2464Z	1 1/2	34.50	230 /1 / 50	850x360x770
3058141	LF3058141	FH2480Z XC	2	54.30	230 /1 / 50	1200x400x810

SILENCED CONDENSING UNITS TECUMSEH TN R134 HBP - VALVE



REPA IT Code	REPA DE Code	Compressors	Motor power HP	Displacement cm ³	Power supply Volt/Ph/Hz	Dimensions mm LxDxH
3058142	LF3058142	CAJ4461Y	1/2+	18.30	230 /1 / 50	850x360x770
3058143	LF3058143	CAJ4511Y	1	32.70	230 /1 / 50	850x360x770
3058144	LF3058144	FH4518Y XC	1 1/2	48.50	230 /1 / 50	1200x400x810

Monoblocks

REFRIGERATION UNITS - MONOBLOCKS RIVACOLD



REPA IT Code	REPA DE Code	Model	Gas	Displacement cm ³	Defrosting	Volume refrigerated	Range	Weight	Power supply
40015736	40015736	SEM007PE11	R290	4.53	Electrical	700 L	+2°C / +8°C	23	230V/1/50Hz
40015737	40015737	SEM014PE11	R290	6.09	Electrical	1400 L	+2°C / +8°C	26	230V/1/50Hz
40015738	40015738	SEL007PE11	R290	12.55	Electrical	700 L	-18°C / -25°C	29	230V/1/50Hz
40015739	40015739	SEL014PE11	R290	20.91	Electrical	1400 L	-18°C / -25°C	31	230V/1/50Hz

COOLING UNITS TECO



REPA IT Code	REPA DE Code	Model	Gas	Compress.	Power cooling	De-frosting	Volume refrig.	Range	Weight	Dimensions mm	Hole mm	Power supply
3058006	LF3058006	STA E-PLV	R290	EMC3119U	348W (*)	Hot gas	700 l	-2/+8°C	18Kg	610x690x290	510x385	230V 50Hz
3058007	LF3058007	STA E-PHV	R290	EMC3134U	535W (*)	Hot gas	1400 l	-2/+8°C	21Kg	610x690x290	510x385	230V 50Hz
3058008	LF3058008	STA E-NLV	R290	NEU2155U	560W (*)	Hot gas	700 l	-15/-20°C	26Kg	610x690x320	510x385	230V 50Hz
3058009	LF3058009	STA E-NHV	R290	NT2180U	820W (*)	Hot gas	1400 l	-15/-20°C	36Kg	610x690x320	510x385	230V 50Hz
3058010	LF3058010	STB E-PLV Rh	R290	EMC3119U	348W (*)	Hot gas	1-4 Doors	-2/+8°C	22Kg	490x285x630	390x305	230V 50Hz
3058011	LF3058011	STB E-PLV Lh	R290	EMC3119U	348W (*)	Hot gas	1-4 Doors	-2/+8°C	22Kg	490x285x630	390x305	230V 50Hz
5231830	LF5231830	STB NLV - High Eff. Lh	R290	NLE12.6CNL	383W (*)	Hot gas	1-3 Doors	-15/-20°C	23Kg	490x285x630	390x305	230V 50Hz
5231833	LF5231833	STB E-PH - High Eff. Lh	R290	KLF5.6CND	414W (*)		1-5 Doors	+2/+10°C	20Kg	490x285x630	390x305	230V 50Hz
5232584	LF5232584	STA E-PL	R290	NBC35NA	256W (*)		700 l	+2/+10°C	16Kg	615x690x295	510x385	230V 50Hz
5233859	LF5233859	STB E-PHV Rh	R290	KLF5.6CND	414W (*)	Hot gas	1-5 Doors	-2/+10°C	20Kg	490x285x630	390x305	230V 50Hz
5233860	LF5233860	STB E-PHV Lh	R290	KLF5.6CND	414W (*)	Hot gas	1-5 Doors	-2/+10°C	20Kg	490x285x630	390x305	230V 50Hz
5232113	LF5232113	STB E-PL Lh	R290	KLF4.0CND	280W (*)		1-3 Doors	+2/+10°C	22Kg	490x285x630	390x305	230V 50Hz
5232114	LF5232114	STB E-PL Rh	R290	KLF4.0CND	280W (*)		1-3 Doors	+2/+10°C	22Kg	490x285x630	390x305	230V 50Hz

GRID FOR COOLING UNITS TECO



REPA IT Code	REPA DE Code	Description	Dimensions mm
3185133	LF3185133	plastic grid for evaporator air flow direction STB	50x122
3185134	LF3185134	stainless steel grid for STB	330x400
3185135	LF3185135	stainless steel grid for STA	525x400

REFRIGERATION UNITS - MONOBLOCKS MTH



REPA IT Code	REPA DE Code	Model	Gas	Compress.	Power cooling	Defro- sting	Volume refrig.	Range	Weight	Dimensions mm	Hole mm	Power supply
3058158	LF3058158	MTA2.0 HU/700 N	R290	EMT6152U	385	Natural	700 l	+2°C / +8°C	22	580x690x310	398x78	230V 50Hz
3058159	LF3058159	MTA2.0 HU/1400 N	R290	NEK6210U	549	Natural	1400 l	+2°C / +8°C	24	580x690x310	398x78	230V 50Hz
3058160	LF3058160	MTA2.0 MU/700 G	R290	EMT6165U	457	Hot Gas	700 l	-5°C / +5°C	25	580x690x310	398x78	230V 50Hz
3058161	LF3058161	MTA2.0 MU/1400 G	R290	NEK6210U	640	Hot Gas	1400 l	-5°C / +5°C	27	580x690x310	398x78	230V 50Hz
3058162	LF3058162	MTA2.0 U/700 G	R290	NEK2150U	567	Hot Gas	700 l	-18°C / -25°C	26	580x690x310	398x78	230V 50Hz
3058163	LF3058163	MTA2.0 U/1400 G	R290	NT2180U	735	Hot Gas	1400 l	-18°C / -25°C	33	580x690x320	398x78	230V 50Hz

Monoblocks

WALL-MOUNTED MONOBLOCK MTH BT - CAPILLARY



REPA IT Code	REPA DE Code	Model	Gas	Motor power HP	Power cooling	Defrosting	Range	Power supply
5155851	LF5155851	UMZ U/03S1 PLUG-IN	R290	1	930W	Hot Gas	-25/-15°C	230V/1/50Hz
5155852	LF5155852	UMZ U/04A1 PLUG-IN	R290	1 1/5	1063W	Hot Gas	-25/-15°C	230V/1/50Hz
5155865	LF5155865	UMZ G/03A1 PLUG-IN	R452a	1 1/5	780W	Electrical	-25/-15°C	230V/1/50Hz
5155866	LF5155866	UMZ G/05A1 PLUG-IN	R452a	1 1/2	962W	Electrical	-25/-15°C	230V/1/50Hz
5155867	LF5155867	UMZ G/08U2 PLUG-IN	R452a	2	1419W	Electrical	-25/-15°C	230V/1/50Hz
5155868	LF5155868	UMZ G/11U2 PLUG-IN	R452a	2 2/3	1722W	Electrical	-25/-15°C	230V/1/50Hz
5155869	LF5155869	T UMZ G/15U3 PLUG-IN	R452a	3	2265W	Electrical	-25/-15°C	400V/3N/50Hz
5155870	LF5155870	T UMZ G/17U3 PLUG-IN	R452a	4	2855W	Electrical	-25/-15°C	400V/3N/50Hz
5155853	LF5155853	UMZ U/08S2 PLUG-IN	R290	2 x 1	1767W	Hot Gas	-25/-15°C	230V/1/50Hz
5155854	LF5155854	UMZ U/13A3 PLUG-IN	R290	2 x 1 1/5	2020W	Hot Gas	-25/-15°C	230V/1/50Hz

WALL-MOUNTED MONOBLOCK MTH TN - CAPILLARY



REPA IT Code	REPA DE Code	Model	Gas	Motor power HP	Power cooling	Defrosting	Range	Power supply
5155844	LF5155844	UMZ HU/04S1 PLUG-IN	R290	1/2	1060W	Hot Gas	-5/+5°C	230V/1/50Hz
5155845	LF5155845	UMZ HU/05S1 PLUG-IN	R290	3/4	1211W	Hot Gas	-5/+5°C	230V/1/50Hz
5155856	LF5155856	UMZ H G/04A1 PLUG-IN	R452a	1/2	1015W	Electrical	-5/+5°C	230V/1/50Hz
5155857	LF5155857	UMZ H G/05A1 PLUG-IN	R452a	5/8	1197W	Electrical	-5/+5°C	230V/1/50Hz
5155858	LF5155858	UMZ H G/07A1 PLUG-IN	R452a	3/4	1405W	Electrical	-5/+5°C	230V/1/50Hz
5155859	LF5155859	UMZ H G/08A1 PLUG-IN	R452a	1	1482W	Electrical	-5/+5°C	230V/1/50Hz
5155860	LF5155860	UMZ H G/12A2 PLUG-IN	R452a	1 1/5	2289W	Electrical	-5/+5°C	230V/1/50Hz
5155862	LF5155862	UMZ H G/16A2 PLUG-IN	R452a	1 1/2	2790W	Electrical	-5/+5°C	230V/1/50Hz
5155863	LF5155863	T UMZ H G/19U3 PLUG-IN	R452a	1 2/3	3278W	Electrical	-5/+5°C	400V/3N/50Hz
5155864	LF5155864	T UMZ H G/23U3 PLUG-	R452a	2	4071W	Electrical	-5/+5°C	400V/3N/50Hz
5155846	LF5155846	UMZ HU/09S2 PLUG-IN	R290	2 x 1/2	2014W	Hot Gas	-5/+5°C	230V/1/50Hz
5155847	LF5155847	UMZ HU/12S2 PLUG-IN	R290	2 x 3/4	2302W	Hot Gas	-5/+5°C	230V/1/50Hz
5155850	LF5155850	UMZHU/18A3 PLUG-IN	R290	2 x 1	3336W	Hot Gas	-5/+5°C	230V/1/50Hz

ELECTRONIC CONTROLLERS



Controllers are the core electronic devices that supervise and regulate system operation, ensuring stable temperatures and optimal performance. They read parameters, such as temperature, pressure and humidity to manage key functions, including compressor activation, fan control, defrost cycles and alarm handling.

By automating these processes, modern controllers **improve energy efficiency**, enhance system reliability and provide precise, consistent control of commercial and industrial refrigeration applications.



More value
for you

- 1** An unbeatable offering in terms of **product range**.
- 2** A broad **portfolio** covering the most renowned brands.
- 3** Additional alternative brands for even more **choice and compatibility**.

Electronic controllers

DIGITAL THERMOMETERS



REPA IT Code	REPA DE Code	Model	Power supply	Probe
3445294	379778	EUREMA TE01	230V	PTC
5060764	378472	EUREMA TE01DEF	230V	PTC
3445160	379518	AKO D14023	230V	NTC (included)
3445537	378274	ARTHERMO ROF-DIG	230V	NTC (included)
7101730	LF7101730	DIXELL XT11S-0010N	12Vac/dc	NTC (included)
3445351	378693	DIXELL XT11S-5000N	230V	NTC (included)
2101714	LF2101714	ELIWELL EM300LX	12Vac/dc	NTC
3445259	378701	ELIWELL EM300LX	230V	NTC

ELECTRONIC CONTROLLERS ELIWELL IC PLUS



REPA IT Code	REPA DE Code	Model	Relay outputs	Power supply	Probe
3445088	379790	IC PLUS 915	8A Out1-8A Out2	12Vac/dc	1-NTC/PTC
3445089	379832	IC PLUS 915	8A Out1-8A Out2	230V	1-NTC/PTC
3445043	378380	IC915LX/P	8A Out1-8A Out2	230V	1-NTC/PTC
3445044	379830	IC PLUS 902	8A Conf.	230V	1-NTC/PTC

ELECTRONIC CONTROLLERS ELIWELL ID NEXT



REPA IT Code	REPA DE Code	Model	Relay outputs	Power supply	Probe
3445600	LF3445600	IDNEXT902P	10A Comp	12Vac/dc	1-NTC/PTC/PT1000
3445601	LF3445601	IDNEXT902P	10A Comp	230V	1-NTC/PTC/PT1000
3445602	LF3445602	IDNEXT961P	20A Comp	12Vac/dc	1-NTC/PTC/PT1000
3445603	LF3445603	IDNEXT961P	20A Comp	230V	1-NTC/PTC/PT1000
3445604	LF3445604	IDNEXT971P/B	20A Comp-8A Def	12Vac/dc	2-NTC/PTC/PT1000
3445605	LF3445605	IDNEXT971P/B	20A Comp-8A Def	230V	2-NTC/PTC/PT1000
3445606	LF3445606	IDNEXT974P/B	20A Comp-8A Def-5A Fan	12Vac/dc	2-NTC/PTC/PT1000
3445607	LF3445607	IDNEXT974P/B	20A Comp-8A Def-5A Fan	230V	2-NTC/PTC/PT1000
3445608	LF3445608	IDNEXT974P/C	20A Comp-8A Def-5A Fan	230V	2-NTC/PTC/PT1000
3445609	LF3445609	IDNEXT974P/CI	VSC 16Vdc-8A Def-10A Fan	230V	2-NTC/PTC/PT1000
3445611	LF3445611	IDNEXT978P/B	10A Comp-8A Def-5A Fan-5A Alarm	230V	2-NTC/PTC/PT1000
3445612	LF3445612	IDNEXT978P/C	10A Comp-8A Def-5A Fan-5A Alarm	230V	2-NTC/PTC/PT1000
3445610	LF3445610	IDNEXT978P/CI	VSC 16Vdc-8A Def-10A Fan-5A Alarm	230V	2-NTC/PTC/PT1000

ELECTRONIC CONTROLLERS ELIWELL ID-ID PLUS



REPA IT Code	REPA DE Code	Model	Relay outputs	Power supply	Probe
3445399	378644	IDPLUS 902	8A Comp	12Vac/dc	1-NTC/PTC/PT1000
3445375	378303	IDPLUS 902	8A Comp	230V	1-NTC/PTC/PT1000
3445400	379837	IDPLUS 961	20A Comp	12Vac/dc	1-NTC/PTC/PT1000
3445376	378298	IDPLUS 961	20A Comp	230V	1-NTC/PTC/PT1000
3445401	378437	IDPLUS 971	20A Comp-8A Def	12Vac/dc	2-NTC/PTC/PT1000
3445377	378304	IDPLUS 971	20A Comp-8A Def	230V	2-NTC/PTC/PT1000
3445402	379836	IDPLUS 974	20A Comp-8A Def-5A Fan	12Vac/dc	2-NTC/PTC/PT1000
3445378	378299	IDPLUS 974	20A Comp-8A Def-5A Fan	230V	2-NTC/PTC/PT1000
3445066	378136	ID975LX	8A Comp-8A Def-5A Fan-5A Alarm	12Vac/dc	2-NTC/PTC
3445389	378436	IDPLUS 978	16A Comp-8A Def-5A Fan-5A Alarm	230V	2-NTC/PTC/PT1000
3445067	LF3445067	ID985LX	8A Comp-8A Def-8A Fan-5A Alarm	12Vac/dc	3-NTC/PTC

ELECTRONIC CONTROLLERS ELIWELL IWC



REPA IT Code	REPA DE Code	Model	Relay outputs	Power supply	Probe
3445079	LF3445079	IWC720S	16A Comp-8A Light	230V	1-NTC
3445525	378142	IWC720S	16A Comp-8A Light	230V	1-NTC
3445085	378141	IWC730S	16A Comp-20A Def-8A Fan	230V	2-NTC
3445078	378139	IWC750	16A Comp-20A Def-8A Fan-8A Alarm-8A Aux/Light	230V	2-NTC
5115983	378520	IWC750 C.L.	16A Comp-20A Def-8A Fan-8A Alarm-8A Aux/Light	230V	2-NTC

BOARDS DISPLAY ELIWELL IWK WIDE



REPA IT Code	REPA DE Code	Model	Features
3445388	378216	IWK WIDE	6 buttons keyboard

Electronic controllers

ELECTRONIC CONTROLLERS ELIWELL IS-EWEM



by Schneider Electric

REPA IT Code	REPA DE Code	Model	Relay outputs	Power supply	Probe
3445037	379398	IS972LX			1
3445038	379533	EWEM233	15A Comp-10A Fan-16A Def	230V	2-NTC/PTC
2102327	378138	IS974LX			1
5061869	378140	EWEM243	15A Comp-10A Def-8A Fan-8A Aux/Alarm	230V	2-NTC/PTC
3445027	379534	10 poles			
2111317	381400	10 poles			

ELECTRONIC CONTROLLERS ELIWELL EWDR



by Schneider Electric

REPA IT Code	REPA DE Code	Model	Relay outputs	Power supply	Probe
3445069	378205	EWDR 981	16A Comp	230V	2-NTC/PTC
3445071	378696	EWDR 983	16A Comp-8A Def	230V	3-NTC/PTC
2102027	378378	EWDR 983 CS LX	16A Comp-8A Def	230V	3-NTC/PTC
3445526	378206	EWDR 985	16A Comp-8A Def-8A Fan-8A Light	230V	3-NTC/PTC
3445072	378379	EWDR 985 CS LX	16A Comp-8A Def-8A Fan-8A Light	230V	3-NTC/PTC

Mounting on DIN slideway

ELECTRONIC CONTROLLERS DIXELL XR-CX E-CLASS



REPA IT Code	REPA DE Code	Model	Relay outputs	Power supply	Probe
3445440	378267	XR02CX-5N0C1	20A Comp	230V	1-NTC
3445443	LF3445443	XR03CX-5N0C1	20A Comp-8A Aux	230V	1-NTC
3445444	LF3445444	XR04CX-5N0C1	20A Comp-8A Defr	230V	2-NTC
3445207	LF3445207	XR04CX-5N0C1	20A Comp-8A Fan	230V	2-NTC
3445441	378273	XR06CX-5N0C1	20A Comp-8A Def-5A Fan	230V	2-NTC

ELECTRONIC CONTROLLERS DIXELL XR-CX



REPA IT Code	REPA DE Code	Model	Relay outputs	Power supply	Probe
2102676	402192	XR10CX-5N0C1	20A Comp	230V	1-NTC/PTC
3445170	378700	XR20CX-0N0C1	20A Comp	12Vac/dc	1-NTC/PTC
3445171	378000	XR20CX-5N0C1	20A Comp	230V	1-NTC/PTC
3445172	378736	XR30CX-0N0C1	20A Comp-8A Aux/Alarm	12Vac/dc	1-NTC/PTC
3445173	379665	XR30CX-5N0C1	20A Comp-8A Aux/Alarm	230V	1-NTC/PTC
3445174	LF3445174	XR40CX-0N0C1	20A Comp-8A Def	12Vac/dc	2-NTC/PTC
3445175	378384	XR40CX-5N0C1	20A Comp-8A Def	230V	2-NTC/PTC
3445298	LF3445298	XR60CX-0N0C3	16A Comp-8A Def-8A Fan	12Vac/dc	2-NTC/PTC
5030321	378224	XR60CX-5N0C0	8A Comp-8A Def-5A Fan	230V	2-NTC/PTC
3445297	402144	XR60CX-5N0C1	20A Comp-8A Def-5A Fan	230V	2-NTC/PTC
5072543	LF5072543	XR64CX-5N0C0	8A Comp-8A Def1-8A Def2-5A Fan	230V	3-NTC/PTC
3445248	LF3445248	XR70CX-0N0C8	16A Comp-16A Def-16A Fan-16A Light/Alarm	12Vac/dc	2-NTC/PTC
3445390	378221	XR70CX-5N0C3	16A Comp-8A Def-5A Fan-8A Light/Alarm	230V	2-NTC/PTC
3445428	378492	XR72CX-0N0C8-U	16A Comp1-16A Comp2-16A Def-16A Fan	12Vac/dc	2-NTC
7106793	LF7106793	XR72CX-0N0C8	16A Comp1-16A Comp2-16A Def-16A Fan	12Vac/dc	2-NTC
5140068	LF5140068	XR75CX-5N7I3	16A Comp-8A Def-8A Light/Aux-5A Fan	230V	4-NTC
7106545	378730	XR80CX-5N0C1	20A Comp-8A Agt	230V	1-NTC

Electronic controllers

ELECTRONIC CONTROLLER DIXELL UNIVERSAL R4



REPA IT Code	REPA DE Code	Model	Relay outputs	Power supply	Probe
3445396	381408	UNIVERSAL R4	8A Comp-8A Def-7A Fan-8A Aux/Alarm	12Vac/dc-230V	2-NTC/PTC

ELECTRONIC CONTROLLERS DIXELL XR-CH



REPA IT Code	REPA DE Code	Model	Relay outputs	Power supply	Probe
3445518	LF3445518	XR10CH-5N2C1	20A Comp	230V	1-NTC
5116646	378532	XR20CH-5N0C1	20A Comp	230V	1-NTC
3445451	LF3445451	XR20CH-5R0C1	20A Comp	230V	1-NTC
3445543	378488	XR20CH-5G0C3	16A Comp	230V	1-NTC
5116757	378558	XR30CH-5N0C1	20A Comp-8A Light/Allarm	230V	1-NTC
3445452	LF3445452	XR60CH-5R0C1	20A Comp-8A Def-5A Fan	230V	2-NTC
3445519	LF3445519	XR60CH-5N2C1	20A Comp-8A Def-5A Fan	230V	2+1-NTC
3445520	LF3445520	XR70CH-5N2C3	16A Comp-8A Def-5A Fan-8A Alarm	230V	2+1-NTC

ELECTRONIC CONTROLLERS DIXELL XW-L/LS/LR/LRH



REPA IT Code	REPA DE Code	Model	Relay outputs	Power supply	Probe
3445178	378222	XW20LS-5N0C1	20A Comp-8A Light	230V	1-NTC
3445449	378703	XW20LR-5N0C0	20A Comp-8A Light	230V	2-NTC
3445453	LF3445453	XW20LRH-5N0C0-D	16A Comp-8A Light	230V	2-NTC
3445180	378228	XW20L-5N0C1	20A Comp-8A Light	230V	1-NTC
2104028	LF2104028	XW30LS-5N0C1	20A Comp-8A Fan-8A Light	230V	1-NTC
5078111	LF507811	XW30LSH-5N0W3-D	20A Comp-8A Light/Def-8A Fan	230V	1-NTC
5069423	LF5069423	XW30LS-5N0C0-N	20A Comp-8A Conf-8A Conf	230V	2-NTC
3445197	402193	XW30L-00000	20A Comp-8A Fan-8A Light	230V	2-NTC
5075984	LF5075984	XW30L-5N0C0	20A Comp-8A Def-8A Fan	230V	2-NTC
5066444	378526	XW30LRH-5N1D0-D	16A Comp-5A Fan-8A Light	230V	2-NTC
3445236	378387	XW40LS-5N0C1	20A Comp-8A Def-8A Light	230V	2-NTC
3445230	379655	XW40L-5N0C1	20A Comp-8A Def-8A Light	230V	2-NTC
3445391	402159	XW40L-5L0D8-X	16A Comp-16A Def-16A Light	230V	2-NTC
3445179	378223	XW60LS-5N0C1	20A Comp-8A Def-8A Fan	230V	2-NTC
3445450	LF3445450	XW60LR-5N0C0	20A Comp-8A Def-5A Fan-5A Light	230V	3-NTC
3445454	LF3445454	XW60LRH-5N0C0-D	16A Comp-16A Def-5A Fan-5A Light	230V	2-NTC
5063222	378689	XW60L-5N0C0	20A Comp-8A Def-8A Fan-8A Light	230V	3-NTC
3445181	378229	XW60L-5N0C1	20A Comp-8A Def-8A Fan-8A Light	230V	2-NTC
3445521	378735	XW60LH-5N6C1-D	20A Comp-8A Def-8A Fan-8A Light	230V	2-NTC
3445392	379699	XW60L-5L0D0-X	20A Comp-8A Def-8A Fan-16A Light	230V	2-NTC
3445435	378691	XW60L-5N0D1-X	20A Comp-8A Aux-8A Fan-8A Light	230V	1+1-NTC
2104961	LF2104961	XW60L-5N0D1-X	20A Comp-8A Def-8A Fan-8A Light	230V	2-NTC
7107867	LF7107867	XW70L-5N0C1	20A Comp-8A Def-8A Fan-8A Light-8A Aux	230V	3-NTC
3445539	378530	XW70LH-5N0W0-B	20A Comp-8A Def-8A Fan-8A Light-8A On/Off	230V	3-NTC
5088030	LF5088030	XW70LT-5N7W0-R	20A Comp-12A Def-8A Fan-8A Light-8A Aux	230V	2+2-NTC
3445257	378388	XW220L-5N0C1	20A Comp-16A Light	230V	2-NTC
3445322	378389	XW230L-5N0C0	20A Comp-16A Light-16A Aux-8A Alarm	230V	2-NTC
3445231	381580	XW260L-5N0C5	20A Comp-8A Def-8A Fan-16A Light	230V	3-NTC
3445413	LF3445413	XW260L-5N0D0-X	20A Comp-16A Def-8A Fan-8A Aux	230V	3-NTC
3445251	378386	XW264L-5N0C5	20A Comp-8A Def-8A Def2-8A Fan-16A On/Off-16A Light	230V	3-NTC
7105111	LF7105111	XW270L-5N0C0	20A Comp-8A Def-8A Fan-8A Alarm-16A Aux-16A Light	230V	3-NTC
3445237	LF3445237	XW271L-5N0C1	20A Comp-8A Def-8A Fan-8A Alarm-16A Heater-16A Light	230V	3-NTC

Electronic controllers

ELECTRONIC CONTROLLERS DIXELL XW-K



REPA IT Code	REPA DE Code	Model	Relay outputs	Power supply	Probe
3445246	379660	XW220K-5N0C0	20A Comp-16A Light	230V	2-NTC
3445247	378225	XW260K-5N0C0	20A Comp-16A Light-8A Def-8A Fan	230V	3-NTC
3445347	378385	XW270K-5N0C0	20A Comp-16A Light-8A Def-8A Fan-8A Alarm-16A Aux	230V	3-NTC
7100499	LF7100499	XW271K-5N0C0	20A Comp-16A Light-8A Def-8A Fan-8A Alarm-16A Heater	230V	3-NTC
2101982	LF2101982	XW570K-5N0C4	20A Comp-16A Light-8A Def-8A Fan-8A Alarm-16A Aux	230V	3-NTC

ELECTRONIC CONTROLLERS DIXELL XM-K



REPA IT Code	REPA DE Code	Model	Relay outputs	Power supply	Probe
3445418	378745	XM470K-510C1	8A Comp-16A Light-8A Fan-20A Def-8A Aux	230V	3-NTC
3445420	LF3445420	XM470K-510C1	20A Comp-16A Light-8 Fan-8 Def-8A Aux	230V	2-NTC

ELECTRONIC CONTROLLERS DIXELL XW-K



REPA IT Code	REPA DE Code	Model	Relay outputs	Power supply	Probe
5072143	378555	XW60K-5N2C0	20A Comp-16A Light-16A Def-8A Fan	230V	4-NTC
2102991	LF2102991	XW60K-5L2C0	20A Comp-16A Light neon-Aux-16A Def-8A Fan	230V	4-NTC
5030856	LF5030856	XW764K-5L2C0	8A Comp-16A Light neon-8A Def1-8A Def2-8A Fan-16A On/off	230V	3-NTC

Electronic controllers

DISPLAY BOARDS DIXELL C-T-V



REPA IT Code	REPA DE Code	Model	Features
2102254	378645	X-REP-00000	display remote
5068548	378640	CX620-000N0	6 buttons keyboard
3445245	379658	T620-000C0	6 buttons keyboard
5052544	378278	T640-000C0	6 buttons keyboard
5054626	LF5054626	T670-000C1	6 buttons keyboard
3445348	378442	T820-000C0	8 buttons keyboard
7100498	381591	T821-000C0	8 buttons keyboard
3445417	LF3445417	T840-100D0-X	8 buttons keyboard
5074970	LF5074970	V620-100C0	6 buttons keyboard

ACCESSORIES DIXELL



REPA IT Code	REPA DE Code	Model
3445232	402818	HOTKEY DIXELL

Key for a quick and easy Dixell's controllers programming. Dimensions 0,8x16x46mm

ELECTRONIC CONTROLLERS DIXELL XW-V/V/S



REPA IT Code	REPA DE Code	Model	Relay outputs	Power supply	Probe
3445182	378377	XW20VS-5N0C0 SHORT	16A Comp-16A Light	230V	2-NTC
5051507	LF5051507	XW30V-5N0C1	20A Comp-8A Light-16A Fan/Heater	230V	2-NTC
3445300	378422	XW60VS-5N0C0 SHORT	16A Comp-16A Def-8A Fan	230V	3-NTC
3445301	378423	XW60V-5N0C1	20A Comp-16A Light-8A Def-8A Fan	230V	2-NTC

Electronic controllers

ELECTRONIC CONTROLLERS DIXELL FULL TOUCH XR-T



REPA IT Code	REPA DE Code	Model	Relay outputs	Power supply	Probe
5240989	LF5240989	XR20T	16A Comp	230/240V 50/60Hz	2-NTC/PTC/PT1000
5240991	LF5240991	XR30T	16A Comp - 8A Fan	230/240V 50/60Hz	2-NTC/PTC/PT1000
5240992	LF5240992	XR60T	16A Comp - 2x8A Fan/Def	230/240V 50/60Hz	2-NTC/PTC/PT1000
5240993	LF5240993	XR70T	16A Comp - 2x8A Fan/Def - 5A Aux	230/240V 50/60Hz	2-NTC/PTC/PT1000

ELECTRONIC CONTROLLERS DIXELL XR-D



REPA IT Code	REPA DE Code	Model	Relay outputs	Power supply	Probe
3445368	LF3445368	XR20D-5N0C1	20A Comp	230V	1-NTC/PTC
3445369	LF3445369	XR30D-5N0C1	20A Comp-8A Aux/Alarm	230V	1-NTC/PTC
3445370	LF3445370	XR40D-5P0C1	20A Comp-8A Def	230V	2-NTC/PTC
3445371	381567	XR60D-5N0C1	20A Comp-8A Def-8A Fan	230V	2-NTC/PTC
3445372	LF3445372	XR160D-5N0C1	8A Comp-8A Def-8A Fan	230V	3-NTC/PTC

ELECTRONIC CONTROLLERS CAREL PJ-PY



CAREL

REPA IT Code	REPA DE Code	Model	Relay outputs	Power supply	Probe
2102955	LF2102955	PJEZSNH0E0 COMPACT	30A Comp	230V	1-NTC
5104943	378030	PJEZSNH000 COMPACT	30A Comp	230V	2-NTC
3445215	370886	PJEZS00000	8A Comp	230V	2-NTC
5057406	378721	PJEZS0P000	16A Comp	230V	2-NTC
5058938	378329	PYAO1C0522	12A Comp	230V	1-NTC
5975202	378673	PYCO1SN50P	12A Comp	230V	2-NTC
5040535	378705	PJEZS0H000	30A Comp	230V	2-NTC
3445216	LF3445216	PJEZS0A000	8A Comp-8A Aux	230V	2-NTC
3445249	LF3445249	PJS1Y0P000	16A Comp-8A Agt	230V	2-NTC
2101745	LF2101745	PJEZS0G000	30A Comp-8A Aux	230V	2-NTC
2102337	LF2102337	PJEZY0H000	30A Comp-8A Def	230V	2-NTC
3445217	378690	PJEZC00000	8A Comp-8A Def-8A Fan	230V	2-NTC
5975201	379779	PYCO1LO51G	12A Comp-8A Def-8A Fan	230V	2-NTC
3445439	LF3445439	PYIA1Z055P	12A Comp-8A Fan-8A Light	230V	2-NTC
3445416	378491	PYIA1Z052N	12A Comp-8A Def-8A Fan	230V	2-NTC
5068601	378475	PJEZC0P000	16A Comp-8A Def-8A Fan	230V	2-NTC
7100643	378283	PYIL1U0525	16A Comp-8A Def-8A Fan	230V	2-NTC
7106435	LF7106435	PJEZC0H000	30A Comp-8A Def-8A Fan	230V	2-NTC
3445332	LF3445332	PJEZC0M000	30A Comp-8A Def-8A Fan	230V	2-NTC

ELECTRONIC CONTROLLERS CAREL IR33



CAREL

REPA IT Code	REPA DE Code	Model	Relay outputs	Power supply	Probe
3445225	LF3445225	IR33S00N00	16A Comp	12Vac	2-NTC
3445908	LF3445908	IR33S0LN00	16A Comp	12/24Vac	2-NTC
3445210	378143	IR33S0LR00	16A Comp	12/24Vac	2-NTC
3445226	378183	IR33Y00N00	16A Comp-8A Def	12Vac	2-NTC
4091609	379512	IREF0EN215	8A Comp-8A Def-5A Fan	230V	2-NTC
4093532	LF4093532	IREF0EN265	8A Comp-8A Def-5A Fan	230V	2-NTC
4092355	379509	IREF0HN245	8A Comp-12A Def-8A Fan	115-230V	2-NTC
5072869	LF5072869	IRIAF0EHA1	12A Comp-8A Def-5A Fan	230V	2-NTC
4091642	LF4091642	IRELCOHN215	12A Comp-8A Def-8A Fan-8A Aux	115-230V	2-NTC
3445227	LF3445227	IR33C00N00	16A Comp-8A Def-8A Fan-8A Aux/Light	12Vac	2-NTC
3445211	378181	IR33C0LB00	16A Comp-8A Def-8A Fan-8A Aux/Light	12/24Vac	2-NTC
3445909	378182	IR33C0LN00	16A Comp-8A Def-8A Fan-8A Aux/Light	12/24Vac	2-NTC

Electronic controllers

ELECTRONIC CONTROLLERS CAREL POWERSPLIT PSB



CAREL

REPA IT Code	REPA DE Code	Model	Relay outputs	Power supply	Probe
3445424	LF3445424	PSBIA01110	2Hp Comp-16A Def-10A Fan-10A Alarm-16A Light-10A Heater	230V	3-NTC

ELECTRONIC CONTROLLERS CAREL PJEZ EASY SPLIT



CAREL

REPA IT Code	REPA DE Code	Model	Relay outputs	Power supply	Probe
5087242	LF5087242	PJEZC8I040	4 - 30A-2Hp-16A-16A	230V 50/60Hz	2-NTC
5090596	LF5090596	connection cable 3000 mm			

BOARDS DISPLAY CAREL POWERSPLIT PST



CAREL

REPA IT Code	REPA DE Code	Model	Features
3390390	LF3390390	PST01VR100	1 input NTC probe
3390388	LF3390388	PSTIALR400	8 buttons keyboard

ELECTRONIC CONTROLLERS CAREL DN



CAREL

REPA IT Code	REPA DE Code	Model	Relay outputs	Power supply	Probe
3445212	LF3445212	DN33S0EN00	16A Comp	230V	2-NTC
3445202	LF3445202	DN33F0ET00	16A Comp-16A Def-8A Fan-8A Aux/Light	230V	2-NTC
3445213	LF3445213	DN33COLB00	16A Comp-16A Def-8A Fan-8A Aux/Light	12-24Vac	2-NTC

Mounting on DIN slideway

Electronic controllers

ELECTRONIC CONTROLLERS CAREL MPXPRO



CAREL

REPA IT Code	REPA DE Code	Model	Relay outputs	Power supply	Probe
3445553	378784	MX30M21HO0	8A-2HP-16A-8A-8A	115/230 V	NTC PTC PT1000
3445554	378786	MX30M24HO0	8A-2HP-16A-8A-8A	115/230 V	NTC PTC PT1000
5109938	378785	MX30M25HO0	8A-2HP-16A-8A-8A	115/230 V	NTC PTC PT1000

ELECTRONIC CONTROLLERS DANFOSS



REPA IT Code	REPA DE Code	Model	Relay outputs	Power supply	Probe	Danfoss Code
40016164	40016164	AK-RC 205C	16A-20A-16A	230V	2-NTC	080Z5002
2104138	S7001668	EKC 202A	8A-8A	230V	2-NTC/PTC/PT1000	084B8521
41065891	41065891	EKC 202C	8A-8A-6A-4A	230V	2-NTC/PTC/PT1000	084B8523
40016165	40016165	ERC 214	16A-2A-2A-2A	230V	2-NTC/PTC/PT1000	080G3463
5236609	LF5236609	ERC111A	16A	230V	2-NTC	080G3231
5236610	LF5236610	ERC112C	16A-8A-8A	230V	4-NTC/PT1000	080G3218
5236614	LF5236614	ERC112D	16A-8A-8A-8A	230V	4-NTC/PT1000	080G3213
5236615	LF5236615	ERC113D	16A-8A-8A-8A	230V	4-NTC/PT1000	080G3253
5232408	379821	ERC211	16A	230V	1-NTC/PTC/PT1000	080G3454
5237580	LF5237580	ERC213	16A-2A-2A	230V	3-NTC/PTC/PT1000	080G3458
3445576	381645	ERC214	16A-8A-3A	230V	2-NTC/PTC/PT1000	080G3295
5237581	LF5237581	RD1107A		12V		080G3241

ELECTRONIC CONTROLLERS EVCO EVK



REPA IT Code	REPA DE Code	Model	Relay outputs	Power supply	Probe
3445119	378774	EVK202N7	16A Comp-8A Def	230V	2-NTC/PTC
3445128	378154	EVK203N7	16A Comp-8A Def-8A Fan	230V	2-NTC/PTC
3445409	LF3445409	EVK214N9	16A Comp-8A Def-8A Fan-8A Light/Conf	230V	2-NTC/PTC

Electronic controllers

ELECTRONIC CONTROLLERS EVCO EV3



REPA IT Code	REPA DE Code	Model	Relay outputs	Power supply	Probe
3445479	378443	EV3X21N7	16A Comp	230V	1-NTC/PTC
3445480	378444	EV3B31N7	30A Comp	230V	1-NTC/PTC
3445481	LF3445481	EV3B32N7	30A Comp-8A Def/Fan/Light/Alarm	230V	2-NTC/PTC
3445482	378445	EV3B33N7	30A Comp-8A Def-5A Fan	230V	2-NTC/PTC
3445513	LF3445513	EV3B43N7	16A Comp-8A Fan(conf.)-5A Light	230V	2-NTC

ELECTRONICAL CONTROLLERS EVCO EV3 200



REPA IT Code	REPA DE Code	Model	Relay outputs	Power supply	Probe
3445514	LF3445514	EV3121N7	16A Comp	230V	1-PTC/NTC
3445515	LF3445515	EV3122N7	16A Comp-8A Def	230V	2-PTC/NTC
3445516	LF3445516	EV3123N7	16A Comp-8A Def-5A Fan	230V	2-PTC/NTC
3445517	378631	EV3294N9	16A Comp-8A Def-5A Fan-5A Aux	230V	2-PTC/NTC

ELECTRONIC CONTROLLERS EVCO EVR



REPA IT Code	REPA DE Code	Model	Relay outputs	Power supply	Probe
3445404	LF3445404	EVR202N7	16A Comp-8A Def/Fan/Aux/Light/Alarm/Heater	230V	2-NTC/PTC
3445483	LF3445483	EVR203N7	16A Comp-8A Def/Light-5A Fan	230V	2-NTC/PTC
3445405	378357	EVR204N7	16A Comp-8A Def-5A Fan-8A Light/Aux/Alarm/Heater	230V	2-NTC/PTC

ELECTRONIC CONTROLLERS EVCO EVR SPLIT VERSION



REPA IT Code	REPA DE Code	Model	Relay outputs	Power supply	Probe
3445484	LF3445484	EVRS204N9	30A Comp-16A Def-8A Fan-16A Light	230V	2+1-NTC/PTC

ELECTRONIC CONTROLLERS EVCO CT



REPA IT Code	REPA DE Code	Model	Relay outputs	Power supply	Probe
5028759	LF5028759	CT1SA0020402	30A Comp-8A Def-5A Evap.fan-5A Cond.fan-5A Light-8A Alar	12Vac	3-NTC

ELECTRONICAL CONTROLLERS EVCO EVF



REPA IT Code	REPA DE Code	Model	Relay outputs	Power supply	Probe
3445511	LF3445511	EVF205	30A Comp-16A Def-8A Fan-16A Aux 1-8A Aux 2	115..230V	3-NTC

Digital controllers for refrigerated display cabinets consisting of a user interface with capacitive touch buttons and a control module.

ELECTRONIC CONTROLLERS EVCO EVJ 200



REPA IT Code	REPA DE Code	Model	Relay outputs	Power supply	Probe
5122827	378778	EVJ203N2VX3WXX2	16A Comp-8A Def-16A Light	12Vac/dc	2-NTC

Electronic controllers

ELECTRONIC CONTROLLERS LAE CD5 CR5



REPA IT Code	REPA DE Code	Model	Relay outputs	Power supply	Probe
3445680	LF3445680	CD5-01WHRB	15A-7A-7A	240V 50/60Hz	1-NTC
3445679	LF3445679	CD5-01WHRW	15A-7A-7A	240V 50/60Hz	1-NTC
5236677	LF5236677	CR5-01WHR	15A-7A-7A	240V 50/60Hz	1-NTC

ELECTRONIC CONTROLLERS LAE AC1-5 AT1-5 AT2-5 AR2-5 AD2-5



REPA IT Code	REPA DE Code	Model	Relay outputs	Power supply	Probe
7106476	LF7106476	AC1-5TS2RW-A	12A Out1-7A Out2	115-230V	1-NTC/PTC
2102285	LF2102285	LTR-5CSRE-A	16A Out1	230V	1-NTC
5073287	379762	AT1-5AS5E-G	16A Comp	230V	1-NTC/PTC
3445485	LF3445485	AT1-5AS5E-AG	16A Comp	230V	1-NTC/PTC
2102845	LF2102845	AT1-5BQ4E-BG	12A Comp-7A Aux	230V	2-NTC/PTC
5194673	LF3445261	AT1-5BS6E-BGK	16A Comp-7A Aux	230V	2-NTC/PTC
3445286	378681	AT1-5BS6E-AG	16A Comp-7A Aux	230V	2-NTC/PTC
3445235	379764	AT2-5BS4E-AG	16A Comp-7A Def-7A Fan	230V	2-NTC/PTC

ELECTRONIC CONTROLLERS AKO LAE LCD-AD



REPA IT Code	REPA DE Code	Model	Relay outputs	Power supply	Probe
3445474	379772	AD-32S35W-B	16A Comp-16A Def-7A Fan-7A Aux1-7A Aux2	115-230V	3-NTC

Electronic controllers

ELECTRONIC CONTROLLERS LAE AC1-27 BR1-27



REPA IT Code	REPA DE Code	Model	Relay outputs	Power supply	Probe
3445493	LF3445493	BR1-27C1S5W-B	16A Comp-8A Def-16A Fan-7A Aux-7A Aux2	115-230V	3-NTC

mounting on DIN slideway

ELECTRONIC CONTROLLERS LAE SSD90



REPA IT Code	REPA DE Code	Model
3445295	378414	PTC probe 2000 mm w/connector
2102101	403465	10-ways flat cable - 2 m

ELECTRONIC CONTROLLERS LAE BR1-28



REPA IT Code	REPA DE Code	Model	Relay outputs	Power supply	Probe
3445475	379803	BR1-28C1S5W-B	16A Comp-16A Def-16A Fan-7A Aux1-7A Aux2	230V	3-NTC
3445476	381380	Remote display DU5S			
3445477	403598	4 wires w/connector - cable 2 m			

Electronic controllers

ELECTRONICAL CONTROLLERS LAE BIT25 LF28 AD2-28



REPA IT Code	REPA DE Code	Model	Relay outputs	Power supply	Probe
3445394	403458	BIT25B13E-A	12A Comp-16A Aux1-4A Aux2	230V	2-NTC
5115305	378253	BD1-28C1S5W-B	16A Comp-16A Def-8A Fan-7A Aux1-7A Aux2	230V	2-NTC
3445395	403459	6-ways flat cable - 1.5 m			
3445288	LF3445288	Remote display LCD-5S			

ELECTRONIC CONTROLLERS AKO D14



REPA IT Code	REPA DE Code	Model	Relay outputs	Power supply	Probe
3445161	379591	D14112	12A Comp	12/24Vac/dc	1-NTC+1 conf
3445162	379460	D14123	12A Comp	230V	1-NTC
3445535	379507	D14123-2	16A Comp	230V	1-NTC+1 conf
3445163	379797	D14212	12A Comp-8A Conf(Fan-Def-Alarm-Light)	12Vac	1-NTC+1 conf
3445533	379314	D14223	12A Comp-8A Conf(Fan-Def-Alarm-Light)	230V	1-NTC+1 conf
3445164	379456	D14323	12A Comp-8A Conf(Def-Alarm-Light)-5A Fan	230V	2-NTC+1 conf
3445544	378426	D14423	6A Comp-6A Def-6A Fan-6A Aux	230V	2-NTC+1 conf

ELECTRONIC CONTROLLERS BETA RC



REPA IT Code	REPA DE Code	Model	Relay outputs	Power supply	Probe
3445551	LF3445551	RC31-6004-II	2Hp Comp	12-24Vac/dc	1-NTC/PTC/PT1000
3445550	LF3445550	RC31-6001-II	2Hp Comp	230V	1-NTC/PTC/PT1000
3744058	LF3744058	RC33-2604-II	2Hp Comp-8A Def-5A Fan	12-24Vac/dc	2-NTC/PTC
3744059	LF3744059	RC33-2601-II	2Hp Comp-8A Def-5A Fan	230V	2-NTC/PTC

ELECTRONIC CONTROLLERS ASCON TECHNOLOGIC Z-Y



REPA IT Code	REPA DE Code	Model	Relay outputs	Power supply	Probe
3445524	378666	E31-DR-VVIABI	16A Comp	230V	1-NTC
3445185	LF3445185	Z31A-GR	16A Comp	12..24Vac/dc	1-NTC/PTC
3445186	381579	Z31A-HR	16A Comp	100..240V	1-NTC/PTC
3445187	LF3445187	Z31-GR	16A Comp	12..24Vac/dc	1-NTC/PTC
3445188	LF3445188	Z31-HR	16A Comp	100..240V	1-NTC/PTC
3445239	378439	TLY25H	16A Out1-8A Out2-8A Out3-8A Out4	230V	2-NTC/PTC
3445538	381435	Z31Y-HS	16A Comp SPDT	100..240V	1-NTC/PTC
3445189	LF3445189	Z31Y-HRR	16A Comp-5A Def	100..240V	1-NTC/PTC
3445190	379363	Y39-HRR	16A Comp-5A Def	100..240V	2-NTC/PTC
3445191	379210	Y39-GRRR	16A Comp-5A Def-5A Fan	12..24Vac/dc	2-NTC/PTC
3445192	381502	Y39-HRRR	16A Comp-5A Def-5A Fan	100..240V	2-NTC/PTC
3445510	LF3445510	Y39C-HRRR	16A Comp-5A Def-5A Fan	100..240V	2-NTC/PTC/PT1000

ELECTRONIC CONTROLLERS ASCON TECHNOLOGIC TLW



REPA IT Code	REPA DE Code	Model	Relay outputs	Power supply	Probe
3445193	LF3445193	TLW24RRR	30A Comp-16A Def-8A Fan-8A Light	230V	2-NTC/PTC

ELECTRONIC CONTROLLERS KIOUR



REPA IT Code	REPA DE Code	Model	Relay outputs	Power supply	Probe
3445434	379494	REF-DF-SM	25A Comp-5A Fan-5A Water level	230	1-PTC
3445433	379493	REF-FR-SM	30A Comp-12A Def-5A Fan-5A Water level-5A On/Off	12Vac/dc	2-PTC

Electronic controllers

ELECTRONIC CONTROLLERS KIOR



REPA IT Code	REPA DE Code	Model	Description	Relay outputs	Power supply	Probe
3445430	379495	REF-FR-SB	Power unit	30A Comp-5A Fan-5A Water level-5A Def-5A On/Off	230	2-PTC
3445432	400339		Flat cable			

ELECTRONIC CONTROLLERS KELD



REPA IT Code	REPA DE Code	Model	Relay outputs	Power supply	Probe
5977431	703619	EKT511IRDR230	Comp 16A	90 / 255V	1 NTC/PTC
5977432	703620	EKT853HBRDTLR902	Comp 20A-Out2 8A-Out3 8A-Out4 16A-Out5 16A	90 / 255V	3 NTC/PTC
5977447	704261	EKT833HBRDTLR90255	Comp 20A-Out2 8A-Out3 8A	90 / 255V	3 NTC/PTC
5977433	703621	EKT511IRDR230	Comp 16A-Out2 8A-Out3 8A-Out4 8A-Out5 16A	230V	3 NTC/PTC
5977424	703612	KLH11G230	1HP 16A	230V	1 %HR (0-1V/0-3V/4-20mA)
5977435	703623	KLT11BBJR230C	Comp 15A	230V	1 Thermocouple type J/K/S
5977427	703615	KLT11-DR230C	Comp 16A	230V	1 NTC/PTC
5977426	703614	KLT11-DSR230C	Comp 16A	230V	1 NTC
5977428	703616	KLT13IDR230C	Comp 16A	230V	3 NTC/PTC
5977440	703628	KLT21MDR230	Out 5A-Timer 5A	230V	1 NTC/PTC
5977434	703622	KLT22Z-PR230C	Out1 16A-Out2 8A	230V	2 NTC/PTC
5977429	703617	KLT23IDR230C	Comp 16A-Out2 8A	230V	3 NTC/PTC
5977430	703618	KLT33IDR230C	Comp 16A-Out2 5A-Out3 8A	230V	3 NTC/PTC
5977439	703627	KLT33STPR230C	Out1 5A-Out2 16A-Out3 8A	230V	3 PTC
5977425	703613	KLTH43C	Out1 8A-Out2 8A-Out3 8A-Out4 8A	230V	1 %HR (0-1V/0-3V/4-20mA) + 2 PTC
5977441	703629	KLT11TIMR230 Timer	Out 16A	230V	
5977436	703624	ST11-DR230	Comp 16A	230V	1 NTC/PTC
5977437	703625	ST23I-DR230	Comp 16A-Out2 5A	230V	3 NTC/PTC
5977438	703626	ST33I-DR230	Comp 16A-Out2 5A-Out3 8A	230V	3 NTC/PTC

Electronic controllers

THERMOMETERS KELD



KELD

REPA IT Code	REPA DE Code	Model	Power supply	Probe type
5977421	703609	KLT01-NR230C	230V	NTC
5977422	703610	EKTBIG01R230C	230V	NTC
5977423	703611	EKTBIG01B230C	230V	NTC

PROBES KELD



KELD

REPA IT Code	REPA DE Code	Model	Probe type	Bulb	Cable length	Range
5977442	703630	PSNTC20	NTC	6x25	1500 mm	-50 / +105°C
5977443	703631	SDTYCANTC20	NTC	6x50	1500 mm	-50 / +105°C
5977444	703632	CAPTC20	PTC	6x35	1500 mm	-50 / +150°C
5977445	703633	KLSH03	HUMIDITY	25X64	1500 mm	10 / 90% RH

ACCESSORIES KELD



KELD

REPA IT Code	REPA DE Code	Model	Description
5977446	703634	KL Key	KELD Programming key

Electronic controllers

ELECTRONIC CONTROLLERS RANCO



REPA IT Code	REPA DE Code	Model	Relay outputs	Power supply	Probe
3445617	LF3445617	RB-800P	20A Comp	230V	1-NTC
3445618	LF3445618	RB-8000P	8A Comp	230V	1-NTC
3445697	LF3445697	RDT-1110	20A Comp	230V	1-NTC
3445698	LF3445698	RDT-3210	20A Comp - 10A Def - 5A Fan	230V	2-NTC
3445699	LF3445699	RDT-2210	20A Comp - 10A Def	230V	2-NTC

ACCESSORIES FOR CONTROLLERS



REPA IT Code	REPA DE Code	Description
7101290	LF7101290	Plastic protection
3445442	LF3445442	Plastic protection for standard formats (71x29) on terminal blocks

ADAPTERS FOR CONTROLLERS



REPA IT Code	REPA DE Code	Description
3445305	378551	plastic adapter reduce hole from 150x31 mm to 71x29 mm

BOXES FOR CONTROLLERS



REPA IT Code	REPA DE Code	Description	Instrument hole mm	Dimension mm
3445303	378227	wall plastic box for vertical keyboards	100x64xh43	56x69
3445302	LF3445302	wall plastic box for VS-Dixell format controllers	135x74xh72	56x72
3445068	LF3445068	wall stainless steel box for standard format controllers and switch	105x105xh72	71x29 - 30x22
3445304	378557	wall plastic box for standard format controllers	108x108xh90	71x29

EWBOX



1

Photo	REPA IT Code	REPA DE Code	Dimensions mm
1	3445056	LF3445056	165x105xh90

FRONT PANELS FOR EWBOX



REPA IT Code	REPA DE Code	No. of holes per instrument	No. of switch holes
3445060	698759	1 - 74x32 mm horizontal	1
3445062	LF3445062	2 - 74x32 mm horizontal	2
3445059	512529	1 - 74x32 mm vertical	2
3445058	LF3445058	2 - 74x32 mm vertical	2
5193235	LF5193235	1 - 74x32 mm horizontal	1

Electrical boards

ELECTRICAL BOARDS AKO



REPA IT Code	REPA DE Code	Model	Relay outputs	Power supply	Probe
3445166	378042	14610	1-16A	230V	1-NTC
3445165	378041	14632	3-16/8/6A	230V	2-NTC

ELECTRICAL BOARDS ASCON TECNOLOGIC



REPA IT Code	REPA DE Code	Model	Relay outputs	Power supply	Probe
3445306	378233	W09HRB	8A Comp	100..240V 50/60Hz	1-NTC
3445307	378234	W09YHRRRB	14A Out1-8A Out2-4A Out3	100..240V 50/60Hz	2-NTC

ELECTRICAL BOARDS DIXELL COOL-MATE



REPA IT Code	REPA DE Code	Model	Relay outputs	Power supply	Probe
3445168	378525	XLR170	6-20A/16A/8A/16A/20A/8A	230V	3-NTC/PTC

CONTROL PANELS DIXELL XER



REPA IT Code	REPA DE Code	Model	Relay outputs	Power supply	Probe
5240836	LF5240836	XER140P -5N1000	2x20A/1x16A/1x8A	230V	2-NTC/PT1000
5240837	LF5240837	XER160P -5N1040	2x20A/2x16A/2x8A	230V	4-NTC/PT1000
5240838	LF5240838	XER241P -5N1000	2x20A/1x16A/1x8A	230V	2-NTC/PT1000
5240839	LF5240839	XER261P -5N1040	2x20A/2x16A/2x8A	230V	4-NTC/PT1000

ELECTRICAL BOARDS ELIWELL WM-COLDFACE



REPA IT Code	REPA DE Code	Model	Relay outputs	Power supply	Probe
3445158	378217	WM961/A	1-16A	230V	1-NTC/PTC
3545002	378713	COLDFACE NT EWRC300	3-2Hp/16A/8A	230V	3-NTC/PTC
3545003	378316	COLDFACE NT EWRC500	5-2Hp/16A/8A/8A/16A	230V	3-NTC/PTC
3545004	378406	COLDFACE NT EWRC500	5-2Hp/16A/8A/8A/16A	230V	3-NTC/PTC
3545007	378447	COLDFACE NT EWRC500 W/B	5-2Hp/16A/8A/8A/16A	230V	3-NTC/PTC

ELECTRICAL BOARDS ELIWELL COLDFACE - COMPLETE CELL CONTROL



REPA IT Code	REPA DE Code	Model	Relay outputs	Power supply	Probe
3445639	LF3445639	EWCR 5010	6-10A	230V	3-NTC/PTC
3445640	LF3445640	EWCR 5030	17-20A	380V	3-NTC/PTC

Electrical boards

ELECTRICAL BOARDS CAREL SMARTCELLA



REPA IT Code	REPA DE Code	Model	Relay outputs	Power supply	Probe
3545005	LF3545005	WE00S1EN00	1-16A	230V	2-NTC
3545006	378549	WE00C2HN00	4-2Hp/16A/8A/8A	230V	2-NTC

ELECTRICAL BOARDS CAREL MASTERCELLA MD



REPA IT Code	REPA DE Code	Model	Relay outputs	Power supply	Probe
3445229	378176	MD33D5EN00	5-30A/16A/8A/8A/2Hp	230V	2-NTC
3445214	378146	MD33D5FB00	5-30A/16A/8A/8A/2Hp	230V	2-NTC

ELECTRICAL PANEL EVCO WiFi



REPA IT Code	REPA DE Code	Model	Outputs	Power supply	Probe
3445584	LF3445584	RS-485 MODBUS / Wi-Fi EPoCA	Comp 30A-Def 16A-Fan 30A-Aux 16A-8A-8A	230V 50/60Hz	3 PTC/NTC/Pt1000

ELECTRICAL CONTROLLER PEGO 2TMS



REPA IT Code	REPA DE Code	Dimensions mm	Power supply	Load type	Description
3445331	LF3445331	203x193x79	230V 50/60Hz	Single-phase	2-temperatures control panel with 1 unit one-phase

ELECTRICAL CONTROLLER PEGO ECP 04



REPA IT Code	REPA DE Code	Power supply	Load type	Main switch for door lock	Outputs	Inputs
3445342	551479	400V 50/60Hz	Three-phase (3Ph+N+Gnd)	16A	3HP-Comp-condenser fan/solenoid valve	Thermostat or pressure switch

ELECTRICAL BOARDS PEGO ECP 200



REPA IT Code	REPA DE Code	Model	Power supply	Load type	Outputs	Inputs
3445340	LF3445340	ECP 200 BASE 4	230V 50/60Hz	Single-phase	2Hp Comp-30A Def-5A Fan-8A Light	2-NTC probe

ELECTRICAL BOARDS PEGO ECP 200



REPA IT Code	REPA DE Code	Model	Power supply	Load type	Outputs	Inputs
3445350	LF3445350	ECP 208 (Eliwell IS974LX + n.2 switch on/off and light)	230V 50/60Hz	Single-phase	2Hp Comp-30A Def 16A Fan-8A Light-8A Alarm	2-NTC probe

Electrical boards

ELECTRICAL CONTROLLER PEGO ECP 202 EXPERT



REPA IT Code	REPA DE Code	Power supply	Load type	Main switch/general protection	Outputs	Inputs
3445341	378692	230V 50/60Hz	Single-phase	2 poles diff. magnetothermics 16A	10A Comp-3A Fan 16A Def-16A Light - 8A Aux/Al	2-NTC probe

ELECTRICAL BOARDS PEGO ECP 300 VD/VD+T



REPA IT Code	REPA DE Code	Power supply	Load type	Main switch	Control	Outputs
3445343	LF3445343	400V (3ph+N+GND)	Three-phase	16A	External on/off	3Hp Comp-4kW Def (3ph+N) 800W Ev.fan-800W Cond.fan/solenoid valve
3445344	LF3445344	400V (3ph+N+GND)	Three-phase	16A	EWPlus 974+Light switch+ Stand-by switch	3Hp Comp-4kW Def (3ph+N) 800W Ev.fan-800W Cond.fan/solenoid valve

ELECTRICAL CONTROLLER PEGO ECP APE 03 - MAN IN COLD ROOM ALARM KIT



REPA IT Code	REPA DE Code	Power supply	Buffer battery	Acoustic characteristics	Visual indicator	Emergency push-button internal room	Auxiliary relay
3445345	LF3445345	230V 50Hz	12Vdc - Complete recharge time 110h - Autonomy 14h	piezoelectric 90db at 1m	Red LED 12Vdc	Red LED 12Vdc NC Contact	8A AC1

Control box visual/acoustic alarm complete with buffer battery and emergency shiny push-button internal room

REMOTE CONTROL ELIWELL REFRIGERATION EXPERT XP/10



REPA IT Code	REPA DE Code	Model	Power supply	Outputs	Inputs
5240888	LF5240888	REFRIGERATION EXPERT XP/10	24V	RS-485	up to 10 connected controllers

Probes

HUMIDITY PROBES



REPA IT Code	REPA DE Code	Model	Dimensions mm	Power supply	Output power	Measurement range
5137151	378076	EVHP523	185x20	8..28Vdc	4..20mA	5..95% RH
3397235	378726	EWHS 2840/W	80x120	9..28Vdc	4..20mA	0..99% RH
3397236	378727	EWHS 3040	80x120	9..28Vdc	4..20mA	0..99% RH
3445169	403390	XH20P	60x120	9..18Vdc	4..20mA	0..99% RH
3445309	LF3445309	DPFC110000	170x98x44	8..32Vdc 12..24Vac	-0.5..1Vdc 4..20mA	0..90% RH

PRESSURE TRANSDUCERS



REPA IT Code	REPA DE Code	Model	Operating range	Output alarm	Power supply	Connection
3445052	LF3445052	FWPA 007	-0.5..7 bar	4..20mA	8..32Vdc	1/4"sae M
3445053	LF3445053	FWPA 030	0..30 bar	4..20mA	8..32Vdc	1/4"sae M
5239661	LF5239661	ALCO PT5B-10M 808360	-0.8..10 bar	4..20 mA	8..32Vdc	
5239662	LF5239662	ALCO PT5B-30M 808362	0..30 bar	4..20 mA	8..32Vdc	M12
5239663	LF5239663	ALCO PT5B-18M 808361	0..18 bar	4..20 mA	8..32Vdc	M12
5239664	LF5239664	ALCO PT5B-50M 808365	0..50 bar	4..20 mA	8..32Vdc	M12
2102430	LF2102430	CAREL SPKT0031C0	-0.5..60 bar	4..20 mA	8..28Vdc	1/4"sae F
2102429	LF2102429	CAREL SPKT0011C0	-0.5..60 bar	4..20 mA	8..28Vdc	1/4"sae F
5109943	LF5109943	CAREL SPKT0013P0	-1..45 bar	0.5 to 4.5Vdc	5Vdc±10%	1/4"sae F
5239660	LF5239660	CAREL SPKT00B1C0	-0.5..60 bar	4..20 mA	8..28Vdc	1/4"sae F

TEMPERATURE PROBES



1

Photo	REPA IT Code	REPA DE Code	Sensor	Bulb ø x L mm	Cable length mm	Range
1	3445070	378699	PTC	6x40 AISI 304	1500 PVC	-30/+80°C
1	3445107	378694	PTC	6x40 AISI 304	3000 PVC	-30/+80°C
1	3397164	LF3397164	PTC	6x40 AISI 304	1500 SIL	-50/+120°C
1	3445183	LF3445183	PTC	6x40 AISI 304	3000 SIL	-50/+120°C
1	3445959	LF3445959	PTC	6x40 AISI 304	5000 SIL	-50/+120°C
1	3445157	378699	PTC	6x40 AISI 304	1500 PVC	-30/+80°C
6	3445981	378194	NTC	7x26 NYLON	1500 PVC	-30/+80°C
5	3445046	402200	NTC	6x20 AISI 304	2000 TPE	-50/+110°C
1	3445156	379343	NTC	6x40 AISI 304	3000 PVC	-30/+80°C
1	3445028	379633	NTC	6x20 AISI 304	4000 PVC	-30/+80°C
1	3445913	379458	NTC	6x40 AISI 304	1500 SIL	-50/+110°C
1	3445155	381569	NTC	6x40 AISI 304	3000 SIL	-50/+110°C
2	40008365	40008365	NTC	6x40 AISI 304	1500 TPE IP68	-40/+110°C
2	41211438	41211438	NTC	6x40 AISI 304	3000 TPE IP68	-40/+110°C
3	3445167	381584	NTC	5x20 TPE	1500 TPE IP68	-50/+110°C
3	3445335	381590	NTC	5x20 TPE	3000 TPE IP68	-50/+110°C
4	3445379	378702	PT1000	6x20 AISI 304	1500 IP68	-50/+110°C
4	3445380	LF3445380	PT1000	6x20 AISI 304	3000 IP68	-50/+110°C

TEMPERATURE PROBES LAE ELECTRONIC



REPA IT Code	REPA DE Code	Sensor	Bulb ø x L mm	Cable length mm	Range
5034123	379784	NTC 2K	6x29	2000 TPE	-40°+120°C
2102338	378454	NTC 2K	6x29	2500 TPE	-40°+120°C
2101461	379805	NTC 10K	6x29	2000 TPE	-40°+120°C

TEMPERATURE PROBES WITH FASTON TERMINALS



1

Photo	REPA IT Code	REPA DE Code	Sensor	Bulb ø x L mm	Cable length mm	Range
1	3445064	378720	NTC	6x40 AISI 304	1500 PVC with faston terminals 2.8	-30°+80°C

AXIAL MOTOR FANS

ebmpapst

ZIEHL-ABEGG



Axial motor fans are designed to move air parallel to the fan's axis, with the airflow entering and exiting in the same direction.

In refrigeration systems, they are commonly used in **condensers and evaporators** to facilitate heat exchange between the refrigerant and surrounding air, contributing to the **system's efficiency and operational stability**.

More value
for you

- 1 One of the **largest distributors** in the industry.
- 2 Access to **all major brands** in the market.
- 3 Highly attractive offers thanks to our leading **purchasing power**.
- 4 A top-tier supply partner for guaranteed **availability and competitive pricing**.

Axial motor fans

AXIAL FANS COMPACT



REPA IT Code	REPA DE Code	Model	Manufacturer	Dims. mm LxDxH	Volt	Hertz	Watt	rpm	Air flow m3/h	Bearing type
7108241	LF7108241	EE60251S1-1000U-999	SUNON	60x60x25	12Vdc	---	1.56	4500	40	sleeve
3540038	601154	AD0612HB-A71GL	ADDA	60x60x25	12Vdc	---	2.76	4500	40	ball
3240630	LF3240630	EE60252B3-000U-A99	SUNON	60x60x25	24Vdc	---	0.65	3000	24	ball
3540028	601679	MF60252V1-A99-A	SUNON	60x60x25	24Vdc	---	1.25	4500	40	vapo
3540027	LF3540027	MA2062-HVL	SUNON	60x60x25	230V	50/60	4	4100	30	vapo
3540040	601670	AD08012HB-257104	ADDA	80x80x25	12Vdc	---	3	3000	69	ball
5004018	LF5004018	PF80251V3-000U-A99	SUNON	80x80x25	12Vdc	---	2.7	4200	90	vapo
3540041	601439	AD08024HB-257104	ADDA	80x80x25	24Vdc	---	3.84	3100	66	ball
3540042	601130	AA8252HB-AT	ADDA	80x80x25	230	50/60	15	2300	29	ball
3240502	LF3240502	SF23080AT-2082HBL.GN	SUNON	80x80x25	230	50/60	14	2450	31	ball
3540072	602322	A08A23HWSF00	COSTECH	80x80x25	230	50/60	16	2600	32	sleeve
3540003	602244	MA2082-HVL.GN	SUNON	80x80x25	230	50/60	4.6	3200	68	vapo
3540043	601081	AA8382HB-AT	ADDA	80x80x38	230	50/60	13.6	2400	41	ball
3240337	LF3240337	SF23080A-2083HBL.GN	SUNON	80x80x38	230	50/60	18	2400	41	ball
3540056	LF3540056	EE92251B3-000U-A99	SUNON	92x92x25	12Vdc	---	1.3	2400	67	ball
3540044	601747	AD0912HB-A71GL	ADDA	92x92x25	12Vdc	---	3.0	2900	83	ball
3540045	601680	AD0924HB-A71GL	ADDA	92x92x25	24Vdc	---	3.6	2900	83	ball
3540046	601055	AA9252HB-AT	ADDA	92x92x25	230	50/60	13.4	2000	47	ball
3240503	LF3240503	SF23092A-2092HBT.GN	SUNON	92x92x25	230	50/60	14.5	2350	51	ball
1540001	LF1540001	PMD2409PMB1-A(2).GN	SUNON	92x92x38	24Vdc	---	12.2	4900	204	ball
3540047	601158	AD1212HB-A71GL	ADDA	120x120x25	12Vdc	---	4.44	2200	149	ball
3540048	601159	AD1224HB-A71GL	ADDA	120x120x25	24Vdc	---	3.12	2000	149	ball
3340156	LF3340156	DP201AT-2212HBT.GN	SUNON	120x120x25	230	50/60	19	2150	112	ball
3540049	601131	AA1252MB-AT	ADDA	120x120x25	230	50/60	21.6	2200	110	ball
3540050	601712	AD1212HB-F51	ADDA	120x120x38	12Vdc	---	4.7	2800	178	ball
3340133	LF3340133	PMD1212PMB2-A	SUNON	120x120x38	12Vdc	---	14.4	3800	289	ball
3540051	601705	AD1224HB-F51	ADDA	120x120x38	24Vdc	---	6.2	2800	178	ball
4088034	601604	AA1282HS-AW	ADDA	120x120x38	230	50/60	16	2600	141	sleeve
7121448	601080	AA1282HB-AT	ADDA	120x120x38	230	50/60	16	2600	141	ball
3540073	602323	A12B23HVBWF0	COSTECH	120x120x38	230	50/60	20	2750	148	ball
3240501	601692	DP200A-2123XBT.GN	SUNON	120x120x38	230	50/60	22	2850	165	ball
3540052	601457	AD1312UB-F51	ADDA	127x127x38	12Vdc	---	12.72	3500	328	ball
3540060	601132	FP-108C	COMMONWEALTH	162x150x55	230	50/60	46	2700	356	ball
3240504	602271	C17B23HTBF00	COSTECH	172x150x38	230	50/60	27	2850	300	ball
3540053	601706	AK1652HB	ADDA	172x150x51	230	50/60	59.8	2600	292	ball
3340157	602263	A2175-HBT-TC.GN	SUNON	172x150x51	230	50/60	25	2800	345	ball

Axial motor fans

ACCESSORIES FOR COMPACT AXIAL FANS



REPA IT Code	REPA DE Code	Description
3240880	LF3240880	Rubber anti-vibration
3540002	LF3540002	Filter fan guards 119x119 mm

CABLES FOR COMPACT AXIAL FANS



REPA IT Code	REPA DE Code	Length mm	Features	Connection	Application
3240521	551318	610	Angled plug (B)	2.8x0.5	DC
3805036	LF3805036	1500	Straight plug (A)	2.8x0.5	AC
3805037	550898	2000	Straight plug (A)	2.8x0.5	AC
2101758	LF2101758	3000	Straight plug (A)	2,8x0.5	AC

Axial motor fans

AXIAL FANS COMPACT EBM-PAPST



ebmpapst

REPA IT Code	REPA DE Code	Model	Dimensions mm LxDxH	Volt	Hertz	Watt	rpm	Air flow m3/h	Connection	Temp. range °C	Bearing type
1240052	LF1240052	612NGH	60x60x25	12Vdc	---	2.6	5600	46	2 wires L=310 mm	-20..+70	sleeve
1240053	LF1240053	8412N	80x80x25	12Vdc	---	2	3100	69	2 wires L=310 mm	-20..+70	ball
1240208	LF1240208	8414N	80x80x25	24Vdc	---	2	3100	69	2 wires L=310 mm	-20..+70	ball
3540034	601908	8550N	80x80x38	230	50	12	2700	50	2 wires L=310 mm	-10..+70	sleeve
3540037	601826	8556V	80x80x38	230	50	12	2700	50	2 flat plug 2.8x0.5	-40..+90	ball
3240515	601038	8556N	80x80x38	230	50	12	2700	50	2 wires L=310 mm	-40..+90	ball
3540009	602234	3412N	92x92x25	12Vdc	---	2.2	2700	84	2 wires L=310 mm	-20..+70	ball
3240518	601074	3414N	92x92x25	24Vdc	---	2.3	2700	84	2 wires L=310 mm	-20..+70	ball
2102290	LF2102290	3856U	92x92x38	230	50	9	1950	54	2 wires L=1500 mm	-40..+90	ball
3240613	601633	3656	92x92x38	230	50	12	2700	75	2 wires L=310 mm	-40..+75	ball
5074596	602241	4412FGM	119x119x25	12Vdc	---	3.2	2400	140	2 wires L=310 mm	-20..+75	sleeve
3540023	602245	4412F	119x119x25	12Vdc	---	5.3	2900	170	2 wires L=310 mm	-20..+60	ball
3540035	602053	4414F	119x119x25	24Vdc	---	5	2900	170	2 wires L=310 mm	-20..+60	ball
7108502	LF7108502	4314L	119x119x32	24Vdc	---	1.2	1550	95	2 wires L=310 mm	-20..+75	ball
1240313	602157	4414ML	119x119x38	24Vdc	---	3.2	3000	168	2 wires L=310 mm	-20..+80	ball
3540036	601656	4114NHH	119x119x38	24Vdc	---	12.4	5000	260	2 wires L=310 mm	-20..+65	ball
3340129	601754	4856Z	119x119x38	230	50	13	1700	100	2 flat plug 2.8x0.5	-40..+75	ball
3540095	LF3540008	VWCF119DSGJS	119x119x38	230	50/60	1.7	1850	100	2 wires L=310 mm	-20..+75	ball
3540004	LF3540004	4586Z	119x119x38	230	50	13	1900	115	2 flat plug 2.8x0.5	-40..+75	ball
1240390	601089	4650N	119x119x38	230	50/60	19	2650	160	2 flat plug 2.8x0.5	-10..+55	sleeve
3240519	601458	4656N	119x119x38	230	50	19	2650	160	2 flat plug 2.8x0.5	-40..+85	ball
2102517	LF2102517	4656NU	119x119x38	230	50	19	2650	160	2 flat plug 2.8x0.5	-40..+85	ball
3340001	601030	4656Z	119x119x38	230	50	19	2650	160	2 flat plug 2.8x0.5	-40..+75	ball
3540032	LF3540032	4656ZW	119x119x38	230	50	19	2650	160	2 wires L=310 mm	-40..+75	ball
2101757	602257	4656ZU	119x119x38	230	50	19	2650	160	2 flat plug 2.8x0.5	-40..+85	ball
5063246	602211	4656ZWU	119x119x38	230	50	19	2650	160	2 wires L=310 mm	-40..+85	ball
3540069	LF3540069	ACi 4420 HU-014	119x119x38	230	50/60	3.9	3000	160	cable with connector	-20..+75	ball
3540071	LF3540071	ACi 4420 HH	119x119x38	230	50/60	4.6	3300	180	2 flat plug 2.8x0.5	-20..+75	ball
3540033	601793	5656S	135x135x38	230	50	30	2700	235	2 flat plug 2.8x0.5	-35..+70	ball
3240634	601113	7056ES W2E142-BB01-01	172x150x38	230	50	29	2800	330	2 flat plug 2.8x0.5	-25..+55	ball
3240520	601088	7855ES W2S130-AA03-01	150x55	230	50/60	45	2800	325	2 wires L=330 mm	-25..+50	ball
3240593	601631	7450ES W2S130-BM03-01	150x55	230	50	47	2700	380	2 wires L=330 mm	-25..+50	ball
3340130	601755	6058ES W2E143-AA09-01	172x51	230	50	24	2800	375	2 flat plug 2.8x0.5	-25..+70	ball
3540013	LF3540013	W2E250-HQ52-12	280x280x80	230	50	136	2500	1230	terminal strip w/capacitor 3µF	-40..+80	ball

Axial motor fans

AXIAL FANS



1



2

Photo	REPA IT Code	REPA DE Code	Model	Diameter mm	Volt	Hertz	Watt	rpm
1	3240666	602247	NMB 4715MS-23W-B5AK	114	230	50/60	15	2600
2	3240686	LF3240686	EBM 4656 TZ	108	230	50	19	2600

AXIAL FANS EBM

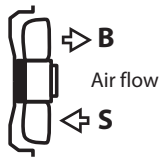

ebmpapst

REPA IT Code	REPA DE Code	Model	Diameter mm	Volt	Hertz	Watt	Ampere	rpm	Air flow rate m3/h	Air direction
3540005	602049	A4E300-AS72-06	300	230	50/60	72	0.32	1320	1130	S
3540006	602048	S4E350-AN02-43	350	230	50	165	0.73	1340	2160	S
3540007	602046	A4E400-AP02-12	400	230	50/60	160	0.73	1430	2675	S

Complete with basket guard grill, electric box and starting capacitor

Axial motor fans

AXIAL FANS EBM

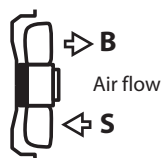

ebmpapst

REPA IT Code	REPA DE Code	Model	Diameter mm	Volt	Hertz	Watt	Ampere	rpm	Air direction
3240594	LF3240594	A4E250-AA04-01	250	230	50/60	32	0.15	1420	S
5065202	LF5065202	A4S250-AH02-01	250	230	50/60	69	0.53	1390	S
3340169	LF3340169	A4E300-AS72-01	300	230	50/60	72	0.32	1380	S
3540054	602152	A4E300-AS72-19	300	230	50/60	72	0.32	1320	S
3340054	LF3340054	A4D300-AS34-01	300	400	50/60	68	0.14	1300	S
3240488	601622	A4E315-AC08-18	315	230	50	95	0.42	1370	B
3240484	601623	A4E315-AC08-19	315	230	50/60	95	0.42	1370	S
2102390	LF2102390	A4E315 AS20-01	315	230	50/60	110	0.52	1350	S
7102134	LF7102134	S4E315 DB74-09	315	230	50/60	100	0.45	1340	S
5073754	LF5073754	A6E330-AA02-10	330	230	50/60	70	0.33	910	S
3240549	601625	A4E330-AP18-01	330	230	50/60	110	0.54	1400	S
2102318	LF2102318	A4E330 AB16-19	330	230	50/60	100	0.45	1350	B
3340053	602010	A4E350-AQ02-09	350	230	50/60	180	0.8	1420	S
3540011	LF3540011	A4E350-AN02-01	350	230	50	165	0.73	1340	S
3240486	LF3240486	A4E400-AP02-01	400	230	50/60	160	0.73	1430	S
2101975	LF2101975	A4E400-AP02-02	400	230	50/60	160	0.73	1430	B
2101782	LF2101782	A4E400-AQ12-02	400	230	50	150	0.66	1400	B
3340147	LF3340147	A4D400-AP12-01	400	400	50/60	135	0.44	1450	S
3240388	602045	A4E450-AP01-01	450	230	50/60	245	1.1	1400	S
3340148	LF3340148	A4D450-AP01-01	450	400	50/60	200	0.48	1380	S
3340146	601628	A4D500-AM03-01	500	400	50	720-550	1.41-0.95	1390-1180	S

ELECTRONIC FANS EBM

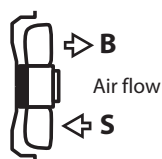

ebmpapst

REPA IT Code	REPA DE Code	Model	Diameter mm	Volt	Hertz	Watt	rpm	Air direction
5235534	776327	A3G300AK1303	300	230	50/60	85	1500	S
5235535	776328	A3G350AN0103	350	230	50/60	165	1475	S
5235536	776329	A3G400BK08H1	400	230	50/60	500	1760	S
5235537	776330	A3G450BL03H3	450	230	50/60	410	1400	S
5235538	776331	A3G500BD5901	500	400	50/60	1300	1770	S
5235540	776332	A3G500BM06H1	500	230	50/60	500	1260	S
5235541	776333	A3G560BB7821	560	230	50/60	735	1230	S
5235542	776334	A3G560BH9901	560	400	50/60	1300	1520	S
5235543	776335	A3G630BE5521	630	230	50/60	730	1020	S
5235545	776336	A3G630BG9701	630	400	50/60	1080	1160	S
5235546	776337	A3G710AS2109	710	400	50/60	2400	1170	S
5235547	776338	A3G800AS2609	800	400	50/60	2200	1000	S
5235548	776339	A3G800BD5731	800	230	50/60	480	630	S

Axial motor fans

BASKET GUARD GRILLS FOR EBM FANS

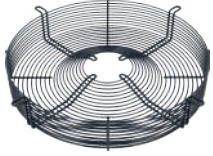

ebmpapst

REPA IT Code	REPA DE Code	Fan diameter mm	Height mm	Distance between fixing holes mm	Version
3240557	601954	250	62	300	Sucking
3240558	LF3240558	250	45	300	Blowing
2102231	LF2102231	300	57	360	Sucking
3240560	601949	300/315	65	368	Sucking
3240559	LF3240559	330	85	405	Sucking
3240561	LF3240561	350	85	422	Blowing/Sucking
2102235	LF2102235	400	80	470	Blowing/Sucking
3240562	601956	400	80	490	Blowing/Sucking
3240492	601957	450	85	522	Blowing/Sucking
3340145	601953	500	92.5	565	Blowing/Sucking

AXIAL FANS ZIEHL-ABEGG

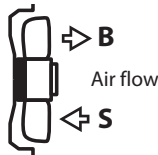

ZIEHL-ABEGG

REPA IT Code	REPA DE Code	Model	Diameter mm	Volt	Hertz	Watt	rpm	Air direction
2103992	LF2103992	IA0300 5P28	300	230	50	34	1330	B
3540088	LF3540088	FB035-4EK.WD.V5	350	230	50	150	1290	S
3240776	601972	FN040-4EK.0F.V7P1	400	230	50	240	1340	S
3540089	LF3540089	FN040-VDK.0F.V7P1	400	400	50	230	1360	S
3240615	601973	FB045-4EK.4F.V4P	450	230	50	480	1325	S
3240587	601974	FB045-VDK.4C.V4P	450	400	50	450	1360	S
3540031	LF3540031	FN050-4EK.4I.V7P1	500	230	50	720	1240	S
3240616	601976	FB050-VDK.4I.V4P	500	400	50	650	1340	S
3340128	601975	FN050-VDK.4I.V7	500	400	50	770	1300	S
3540030	LF3540030	FN050-6EK.4F.V7P3	500	230	50	270	900	S
3540029	LF3540029	FN050-SDK.4F.V7P1	500	400	50	290	880	S
3540090	LF3540090	FN050-VDS.4I.V7P1	500	400	50	490	1300	S
3540091	LF3540091	FB056-VDK.4I.V4L	560	400	50	640	1360	S
3540015	LF3540015	FB063-SDK.4I.V4P	630	400	50	480	860	S
3340189	601977	FN063-SDK.4I.V7	630	400	50	620	900	S
3540092	LF3540092	FN063-VDK.6N.V7P7	630	400	50	1750	1330	S

Complete with basket guard grill, electric box and starting capacitor

Axial motor fans

AXIAL FANS WEIGUANG

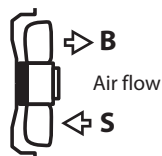

REPA IT Code	REPA DE Code	Model	Diameter mm	Volt	Hertz	Watt	rpm	Air direction
7135178	602185	YWF4E-250S	250	230	50	50	1380	S
3240654	601880	YWF4E-300S	300	230	50	85	1350	S
5098706	LF5098706	YWF4E-300B	300	230	50	85	1350	B
3240655	601881	YWF4E-315S	315	230	50	95	1350	S
3240656	601882	YWF4E-330S	330	230	50	100	1300	S
3240657	601883	YWF4E-350S	350	230	50	126	1420	S
3240658	601884	YWF4E-400S	400	230	50	180	1380	S
3540084	LF3540084	YWF4D-400S	400	400	50	180	1420	S
3540061	601885	YWF6E-450S	450	230	50	110	875	S
5181720	LF5181720	YWF6D-450S	450	400	50	250	1350	S
3540085	LF3540085	YWF6E-500S	500	230	50	208	1320	S
3540086	720169	YWF6D-500S	500	400	50	210	900	S
3540087	720170	YWF6D-630S	630	400	50	550	900	S

Complete with basket guard grill, electric box and starting capacitor

FAN MOTORS

ebmpapst

ELCO®

EURO
MOTORS
ITALIA



Fan motors in refrigeration systems are electric or electronic motors designed to drive fans to move air across condenser and evaporator coils.

Their primary role is to **enhance heat transfer** by ensuring proper airflow over these components, allowing the system to cool or condense the refrigerant efficiently and maintain stable operating conditions.

More value
for you



1

One of the **largest distributors** in the industry.

2

Full access to all **major brands** for maximum compatibility.

3

Highly **attractive offers** thanks to our leading market position.

4

Technical specs and **detailed documentation** available on our **webshop**.

ALUMINUM FANS FOR MOTORS



REPA IT Code	REPA DE Code	Fan diameter mm	Pitches	Version
3240960	601566	154	28°	Sucking
3240961	601553	172	28°	Sucking
1240373	LF1240373	172	40°	Sucking
3240220	601070	200	28°	Sucking
3240222	601283	230	28°	Sucking
3240964	601567	254	28°	Sucking
3240965	601410	300	28°	Sucking
3240411	601568	154	28°	Blowing
3240412	601569	172	28°	Blowing
3240393	601570	200	28°	Blowing
3240394	601571	230	28°	Blowing
3240395	601573	254	28°	Blowing
3240403	601574	300	28°	Blowing

RINGS FOR MOTORS



REPA IT Code	REPA DE Code	Fan diameter mm	External diameter mm	Height mm
3240408	601585	154	200	49
3240969	601586	172	220	49
3240970	601587	200	248	49
3240409	601588	230	278	49
3240971	601589	254	302	49
3240972	601590	300	350	49

Fan motors

MOTOR BRACKETS STRAIGHT



REPA IT Code	REPA DE Code	Height mm	Distance between fixing holes mm
3240950	601597	39	81
3240951	601075	52	81
3240221	601576	72	81
3240223	601076	84	81
3240954	601578	109	78

MOTOR BRACKETS CROSS



REPA IT Code	REPA DE Code	Height mm
3805024	LF3805024	59
3805025	LF3805025	73
3805026	LF3805026	82
3805027	LF3805027	112
3805028	LF3805028	120

ADJUSTABLE UNIVERSAL SUPPORT



REPA IT Code	REPA DE Code	Height mm
3805029	LF3805029	72-150

GRIDS FOR PENTAVALENT MOTORS



REPA IT Code	REPA DE Code	Fan diameter mm	Height mm	Distance between fixing holes mm
3185088	601581	200	25	236
3185093	601582	230	27	266
3185089	602226	254	25	290
3185090	602227	300	28	344

MOTORS WEIGUANG YZF PENTAVALENT



REPA IT Code	REPA DE Code	Model	Watt in	Watt out	Volt	Hertz	Nominal speed rpm
3240910	601020	YZF 5-13-26	33	5	230	50/60	1300
3240911	601022	YZF 10-20-26	40	10	230	50/60	1300
3240912	601023	YZF 16-25-26	70	16	230	50/60	1300
3240913	601024	YZF 25-40-26	95	25	230	50/60	1300
3240914	601050	YZF 34-45-26	120	34	230	50/60	1300

ELECTRONIC MOTORS WEIGUANG ECM



REPA IT Code	REPA DE Code	Model	Power supply	Power Watt	Nominal speed rpm
3340256	601877	7108	220-240V 50/60Hz	5	1300
3340257	601878	7112	220-240V 50/60Hz	15	1300
3340258	601879	7120	220-240V 50/60Hz	20	1300

Energy saving

Fan motors

MOTORS ELCO N T3



REPA IT Code	REPA DE Code	Model	Watt in	Watt out	Power supply	Nominal speed rpm
3240413	602222	N 25-40/1286	95	25	230V 50/60Hz	1300
3240414	602221	N 34-45/389	120	34	230V 50/60Hz	1300

MOTORS ELCO N T4 PLUG-IN



REPA IT Code	REPA DE Code	Model	Watt in	Watt out	Power supply	Nominal speed rpm
3340113	601890	N 10-20/079	38	10	230V 50/60Hz	1300
3340114	601891	N 16-25/110	65	16	230V 50/60Hz	1300

MOTORS ELCO N T4 WITH BEARING



REPA IT Code	REPA DE Code	Model	Watt in	Watt out	Power supply	Nominal speed rpm
3340110	601762	N 10-20/1456	38	10	230V 50/60Hz	1300
3340111	601763	N 16-25/1457	65	16	230V 50/60Hz	1300
3340112	601764	N 25-40/1458	95	25	230V 50/60Hz	1300

MOTORS ELCO N T5 PENTAVALENT



REPA IT Code	REPA DE Code	Model	Watt in	Watt out	Power supply	Nominal speed rpm
3240210	601430	N 5-13	32	5	230V 50/60Hz	1300
3240211	601427	N 10-20	38	10	230V 50/60Hz	1300
3240902	601528	N 16-25	65	16	230V 50/60Hz	1300
3242829	602057	N 18-30	73	18	230V 50/60Hz	1300
3240903	601529	N 25-40	95	25	230V 50/60Hz	1300
3240904	601530	N 34-45	120	34	230V 50/60Hz	1300

MOTORS ELCO N T7



REPA IT Code	REPA DE Code	Model	Watt in	Watt out	Power supply	Nominal speed rpm	Shaft length mm
3340123	602218	N 25-45/1327	95	25	230V 50/60Hz	1300	28

MOTORS ELCO N T7



REPA IT Code	REPA DE Code	Model	Watt in	Watt out	Power supply	Nominal speed rpm	Shaft length mm
3340106	LF3340106	N 10-20/1796	38	10	230V 50/60Hz	1300	121

Fan motors

MOTORS ELCO N T8



REPA IT Code	REPA DE Code	Model	Watt in	Watt out	Power supply	Nominal speed rpm	Shaft ø mm	Shaft length mm
7103478	602251	VNT 18-30/723	73	18	230V 50/60Hz	1300	21	7

MOTORS ELCO R



REPA IT Code	REPA DE Code	Model	Watt in	Watt out	Power supply	Nominal speed rpm	Capacitor µF	Shaft length mm
3240383	601608	R 18-25/002	62	18	230V 50/60Hz	2600	2	15.5

MOTORS ELCO N T8



REPA IT Code	REPA DE Code	Model	Watt in	Watt out	Power supply	Nominal speed rpm	Shaft ø mm	Shaft length mm
3240428	602212	N 25-40/716	105	25	230V 50/60Hz	1300	43	7

MOTORS ELCO N T8



REPA IT Code	REPA DE Code	Model	Watt in	Watt out	Power supply	Nominal speed rpm	Shaft ø mm	Shaft length mm
3340048	LF3340048	N 25-45/887	95	25	230V 50/60Hz	1300	50.5	9.52

MOTORS ELCO 3FBT



REPA IT Code	REPA DE Code	Model	Watt in	Watt out	Power supply	Nominal speed rpm	Capacitor μ F	Shaft \varnothing mm	Shaft length mm
3240490	601420	3FBT 50-40/15	120	45	230V 50/60Hz	1300	2	19	9.52

ELECTRONIC MOTORS ELCO ECM



REPA IT Code	REPA DE Code	Model	Power supply	Power Watt	Nominal speed rpm
3340168	601886	ECM 12	230V 50/60Hz	9/14	1400
3340215	601887	ECM 20	230V 50/60Hz	17/25	1400

Energy saving

MOTORS EMI 5-82 CE PENTAVALENT



REPA IT Code	REPA DE Code	Model	Power supply	Watt in	Watt out	Nominal speed rpm
3240637	602214	5-82-CE 1305	230V 50/60Hz	30	5	1300
3240635	602213	5-82-CE 2010	230V 50/60Hz	40	10	1300
3340218	LF3340218	5-82-CE 2010/4	230V 50/60Hz	40	10	1300
3240636	602273	5-82-CE 3016	230V 50/60Hz	70	16	1300
3340126	602064	5-82-CE 3016/4	230V 50/60Hz	70	16	1300
3340124	602215	5-82-CE 4025	230V 50/60Hz	115	25	1300
3340127	602216	5-82-CE 4025/5	230V 50/60Hz	115	25	1300

Fan motors

MOTORS EMI 82E



REPA IT Code	REPA DE Code	Model	Watt in	Watt out	Power supply	Nominal speed rpm
5004173	LF5004173	83E-3016/11	75	16	230V 50/60Hz	1300
1240122	LF1240122	82E-3016/55	75	16	230V 50/60Hz	1300

MOTORS EMI 82CE



REPA IT Code	REPA DE Code	Model	Watt in	Watt out	Power supply	Nominal speed	Shaft ø mm	Shaft length mm
3340195	LF3340195	82CE-3025/G1	120	25	230V 50/60Hz	1300	9.52	45

MOTORS EMI 83D



REPA IT Code	REPA DE Code	Model	Watt in	Watt out	Power supply	Nominal speed rpm	Capacitor µF	Shaft ø mm	Shaft length mm
3240631	601524	83D-2535/23	95	35	230V 50/60Hz	1300	2.5	9.52	34

MOTORS EMI 83D



REPA IT Code	REPA DE Code	Model	Watt in	Watt out	Power supply	Nominal speed rpm	Capacitor µF	Shaft ø mm	Shaft length mm
3240905	LF3240905	83D-4050/16	100	50	230V 50/60Hz	1300	2.5	9.52	24

MOTORS EMI 101M



REPA IT Code	REPA DE Code	Model	Power supply	Watt IN	Watt OUT	Ampere	Speed rpm	Capacitor μ F
3340197	LF3340197	101M-40120/R	230V 50Hz	245	120	1	1300	10
3240881	601554	101M-50130/3	230V 50/60Hz	190	130	0.8	1300	3.15
3340196	LF3340196	101M-50150/R	230V 50Hz	270	150	1.3	1300	12.5

MOTORS EBM M4Q045 PENTAVALENT



REPA IT Code	REPA DE Code	Model	Watt in	Watt out	Volt	Hertz	Nominal speed rpm
3240581	601756	M4Q045-BD01-75	29	5	230	50/60	1300
3240580	601757	M4Q045-CA03-75	36	10	230	50/60	1300
3240626	601758	M4Q045-CF01-75	60	16	230	50/60	1300
3240627	601759	M4Q045-DA01-75	70	18	230	50/60	1300
3240628	601760	M4Q045-EA01-75	90	25	230	50/60	1300
3240629	601761	M4Q045-EF01-75	110	34	230	50/60	1300
5033962	LF5033962	M4Q045-CA03-51	36	10	230	50/60	1300
2101977	LF2101977	M4Q045-CF01-01	60	16	230	50/60	1300

ELECTRONIC MOTORS EBM iQ



REPA IT Code	REPA DE Code	Model	Power supply	Power Watt	Nominal speed rpm
3340055	601893	iQ3612	230V 50/60Hz	10	1300

Energy saving

COMPONENTS



The efficiency and reliability of a refrigeration system depend on the proper operation of **valves, filters, control devices, heat exchangers and line components.**

This chapter brings together the essential elements for regulation, safety, measurement and circuit management,

along with spare parts for cold rooms, refrigerated cabinets and HVAC applications. **Proper maintenance** and the timely replacement of worn components help prevent failures, reduce energy consumption and extend the lifespan of the system, **ensuring faster and more effective repair interventions.**

*More value
for you*

- 1** A **wide portfolio** of all key refrigeration components.
- 2** **Coverage** across refrigerated cabinets, ice machines, blast chillers, cold rooms, and more.
- 3** Essential and specialized parts always available. **You name it, we have it!**

RETENTION VALVES CASTEL



REPA IT Code	REPA DE Code	Model	Threaded connection SAE	ODF connection mm - in.	Kv factor m ³ /h	Length mm	Diameter mm
3150021	LF3150021	3112/2	1/4" MM	-	0.5	56	16
3150022	750561	3132/2	-	6 - 1/4"	0.5	92	16
3150023	750811	3132/M10	-	10	1.5	107	20
3150024	750559	3132/M12	-	12	1.8	132	22
3150025	750560	3132/5	-	16 - 5/8"	3.3	139	27
3150026	LF3150026	3132/M18	-	18	5	165	33
3150027	LF3150027	3132/7	-	22 - 7/8"	5	165	33

SAFETY VALVES CASTEL



REPA IT Code	REPA DE Code	Model	Connection IN OUT	Orifice cross-section mm ²	Efflux coefficient Kd	Calibration range -bar	Length mm	Diameter mm
3150016	LF3150016	3060/23C300	1/4"M - 3/8"M	38.5	0.63	30	80	21.5
3150017	LF3150017	3060/34C300	3/8"M - 1/2"M	38.5	0.69	30	80	21.5
3150018	LF3150018	3060/45C300	1/2"M - 5/8"M	70.9	0.45	30	89	24.5

THERMOSTATIC VALVES DANFOSS TUB/TUBE



REPA IT Code	REPA DE Code	Model	Danfoss Code	Direction	Connection Inlet - Outlet	Refr. gas	Orifice	Rated capacity kW - TR	Equal. pressure	Working range
3150063	750705	TUB	068U2076	Angleway	6 mm - 12 mm	R404a/R507	1	0.7 - 0.19	Internal	-40°/+10°C
3150053	LF3150053	TUB	068U2077	Angleway	6 mm - 12 mm	R404a/R507	2	1 - 0.28	Internal	-40°/+10°C
3150064	LF3150064	TUB	068U2078	Angleway	6 mm - 12 mm	R404a/R507	3	1.4 - 0.39	Internal	-40°/+10°C
3150054	LF3150054	TUB	068U2079	Angleway	6 mm - 12 mm	R404a/R507	4	2.1 - 0.60	Internal	-40°/+10°C
3150065	750016	TUB	068U2000	Angleway	6 mm - 12 mm	R134a	1	0.7 - 0.19	Internal	-40°/+10°C
3150066	LF3150066	TUB	068U2001	Angleway	6 mm - 12 mm	R134a	2	1 - 0.28	Internal	-40°/+10°C
3150059	LF3150059	TUB	068U2002	Angleway	6 mm - 12 mm	R134a	3	1.4 - 0.39	Internal	-40°/+10°C

Valves

THERMOSTATIC VALVES DANFOSS GAS R290



REPA IT Code	REPA DE Code	Model	Danfoss Code	Direction	Connection Inlet - Outlet	Refr.gas	Orifice	Rated capacity kW - TR	Equal. pressure	Working range
3150193	LF3150193	TUB	068U3713	Angleway	6 mm - 12 mm	R290	1	0.94 - 0.27	Internal	-40°/+10°C
5238770	LF5238770	TD1	068N5603	Angleway	1/4 - 3/8	R290		0.87 - 0.25	Internal	-40°/+10°C
5238771	LF5238771	TD1	068N5607	Angleway	1/4 - 3/8	R290	1	1.27 - 0.36	Internal	-40°/+10°C
5238772	LF5238772	TD1	068N5634	Angleway	1/4 - 3/8	R290	2	2.02 - 0.58	Internal	-40°/+10°C
5238773	LF5238773	TD1	068N5662	Angleway	1/4 - 3/8	R290	3	3.14 - 0.89	Internal	-40°/+10°C

THERMOSTATIC VALVES DANFOSS T2/TE2



REPA IT Code	REPA DE Code	Model	Danfoss Code	Connection Inlet - Outlet	Refrigerant gas	Equalisation of pressure	Working range	MOP
3150041	750012	TN2	068Z3346-068Z3542	3/8"sae - 1/2"sae	R134a	internal	-40°/+10°C	
3150112	750523	TN2	068Z3384-068Z3264	3/8"sae - 12mm ODS	R134a	internal	-40°/+10°C	
3150042	750013	TEN2	068Z3348-068Z3543	3/8"sae - 1/2"sae	R134a	external - 1/4"sae	-40°/+10°C	
3150113	750810	TEN2	068Z3386-068Z3634	3/8"sae - 12mm ODS	R134a	external - 6mm ODS	-40°/+10°C	
3150105	LF3150105	TEN2	068Z3390-068Z3635	3/8"sae - 12mm ODS	R134a	external - 6mm ODS	-40°/+10°C	MOP55 (+15°C)
3150043	750014	TS2	068Z3400-068Z3508	3/8"sae - 1/2"sae	R404a/R507	internal	-40°/+10°C	
3150114	LF3150114	TS2 NM	068Z3406-068Z3639	3/8"sae - 1/2"sae	R404a/R507	internal	-40°/-5°C	MOP75 (0°C)
3150111	750801	TS2	068Z3435-068Z3482	3/8"sae - 12mm ODS	R404a/R507	internal	-40°/+10°C	
3150044	750015	TES2	068Z3403-068Z3555	3/8"sae - 1/2"sae	R404a/R507	external - 1/4"sae	-40°/+10°C	
3150163	LF3150163	TES2 NL	068Z3409-068Z3451	3/8"sae - 1/2"sae	R404a/R507	external - 1/4"sae	-40°/-15°C	MOP50 (-10°C)
3150106	LF3150106	TES2	068Z3422-068Z3478	3/8"sae - 12mm ODS	R404a/R507	external - 6mm ODS	-40°/+10°C	
3150143	LF3150143	TES2	068Z3417-068Z3453	3/8"sae - 1/2" in ODS	R404a/R507	external - 1/4" in ODS	-40°/+10°C	MOP120 (+15°C)
3150108	LF3150108	TES2 NM	068Z3442-068Z3655	3/8"sae - 12mm ODS	R404a/R507	external - 6mm ODS	-40°/-5°C	MOP75 (0°C)
3150110	LF3150110	TES2 NL	068Z3437-068Z3648	3/8"sae - 12mm ODS	R404a/R507	external - 6mm ODS	-40°/-15°C	MOP50 (-10°C)
3150100	LF3150100	TES2 B	068Z3428-068Z3646	3/8"sae - 12mm ODS	R404a/R507	external - 6mm ODS	-60°/-25°C	MOP30 (-20°C)
5137654	LF5137654	T2	068Z3727-068Z3731	3/8"sae - 1/2"sae	R448A/R449A	internal	-40°/+10°C	
3150192	LF3150192	T2	068Z3729-068Z3733	3/8"sae - 1/2"sae	R448A/R449A	internal	-40°/+10°C	
5133322	750521	TS2	068Z3414/068Z3467	3/8"sae - 1/2"sae	R404a/R507	internal	-40°/+10°C	
5187648	LF5187648	TE2	068Z3728-068Z3732	3/8"sae - 1/2"sae	R448A/R449A	external - 1/4"sae	-40°/+10°C	

NOZZLES DANFOSS



REPA IT Code	REPA DE Code	Danfoss Code	Model
3150045	750020	068-2002	0X
3150046	750021	068-2003	00
3150047	750022	068-2010	01
3150048	750023	068-2015	02
3150049	750024	068-2006	03
3150050	750483	068-2007	04
3150051	750484	068-2008	05
3150052	750485	068-2009	06

NOZZLES DANFOSS FOR WELDING ADAPTER



REPA IT Code	REPA DE Code	Danfoss Code	Model
3150134	LF3150134	068-2089	0X
3150135	LF3150135	068-2090	00
3150136	LF3150136	068-2091	01
3150137	LF3150137	068-2092	02
3150103	LF3150103	068-2093	03
3150138	LF3150138	068-2094	04
3150139	LF3150139	068-2095	05
3150140	LF3150140	068-2096	06

WELDING ADAPTERS DANFOSS



REPA IT Code	REPA DE Code	Danfoss Code	Welding connection ODF mm
3150141	LF3150141	068-2063	6
3150142	LF3150142	068-2061	10

Valves

THERMOSTATIC VALVES HONEYWELL AMV



Honeywell

REPA IT Code	REPA DE Code	Model	Honeywell Code	Connection Inlet - Outlet	Equalisation of pressure	Evaporation pressure range
3150101	LF3150101	AMV	A0003	3/8"sae - 1/2"sae		3.2 bar
5033701	750445	AMVX	00002	3/8"sae - 1/2"sae	1/4"sae	2.5 - 3.5 bar

THERMOSTATIC VALVES HONEYWELL TMV/TMVX



Honeywell

REPA IT Code	REPA DE Code	Model	Honeywell Code	Connection Inlet - Outlet	Refrigerant gas	Equalisation of pressure	Working range	MOP
3150115	LF3150115	TMV	00005	3/8"sae - 1/2"sae	R134a		-30°/+15°C	
3150116	LF3150116	TMV	00012	3/8"sae - 1/2"sae	R404a/R507		-30°/+15°C	
3150001	LF3150001	TMV	00008	3/8"sae - 1/2"sae	R404a/R507		-50°/0°C	
3150038	750017	TMV	00009	3/8"sae - 1/2"sae	R404a/R507		-50°/-27°C	-18°C
3150130	LF3150130	TMVX	00105	3/8"sae - 1/2"sae	R134a	1/4"sae	-30°/+15°C	
3150132	LF3150132	TMVX	00112	3/8"sae - 1/2"sae	R404a/R507	1/4"sae	-30°/+15°C	
3150131	LF3150131	TMVX	00108	3/8"sae - 1/2"sae	R404a/R507	1/4"sae	-50°/0°C	

NOZZLES HONEYWELL



Honeywell

REPA IT Code	REPA DE Code	Model
3150119	LF3150119	VD 0.3
3150120	LF3150120	VD 0.5
3150121	LF3150121	VD 0.7
3150122	750026	VD 1.0
3150123	LF3150123	VD 1.5
3150124	LF3150124	VD 2.0
3150125	LF3150125	VD 2.5
3150126	LF3150126	VD 3.0
3150127	LF3150127	VD 3.5
3150128	LF3150128	VD 4.5
3150129	LF3150129	VD 4.75

THERMOSTATIC VALVES SANHUA



REPA IT Code	REPA DE Code	Model	Sanhua Code	Connection Inlet - Outlet	Refrigerant gas	Equalisation of pressure	Working range
3150154	750676	RFKA03-3.4-04	RFKA03-3.4-04	3/8 sae - 12 mm ODS	R404A/R507A	internal	-40°C / +10°C
3150145	LF3150145	RFKA03-3.4-21	RFK-24013	3/8 sae - 1/2 sae	R404A/R507A	internal	-40°C / +10°C
3150150	750675	RFKA03E-3.4-02	RFK-24016	3/8 sae - 12 mm ODS	R404A/R507A	external	-40°C / +10°C
3150151	750815	RFKA04-4.0-29	RFK-24021	3/8 sae - 12 mm ODS	R134	internal	-40°C / +10°C
3150152	750817	RFKA04E-4.0-17	RFK-24022	3/8 sae - 12 mm ODS	R134	external	-40°C / +10°C
3150148	750814	RFKA04E-4.0-19	RFK-24020	3/8 sae - 1/2 sae	R134	external	-40°C / +10°C
3120698	LF3120698	RFKH03-4.8-03	10201003402	3/8 sae - 12 mm ODS	R404A/R507A	internal	-40°C / +10°C
3120697	LF3120697	RFKH03-4.8-21 RFK-24073	10201003702	3/8 sae - 1/2 sae	R404A/R507A	internal	-40°C / +10°C
3120699	LF3120699	RFKH03E-4.8-15 RFK-24074	10201003802	3/8 sae - 1/2 sae	R404A/R507A	external	-40°C / +10°C
3150153	LF3150153	RFKH11E-4.5-324	10201014102	3/8 sae - 12 mm ODS	R452A	external	-40°C / +10°C
3120696	LF3120696	RFKH04E-2.9-17	10201003902	3/8 sae - 12 mm ODS	R134a	external	-40°C / +10°C
3120694	LF3120694	RFKH04-2.9-29	10201004202	3/8 sae - 12 mm ODS	R134a	internal	-40°C / +10°C
5238170	LF5238170	RFKH05E-7.6-36	10201005502	3/8 sae - 12 mm ODS	R410a	external	-40°C / +10°C
3150179	LF3150179	RFKH05-7.6-37	10201005602	3/8 sae - 12 mm ODS	R410a	internal	-40°C / +10°C
5238171	LF5238171	RFKH08E-6.1-47	10201012302	3/8 sae - 12 mm ODS	R448a/R449a	external	-40°C / +10°C
5238172	LF5238172	RFKH08-6.1-50	10201013302	3/8 sae - 12 mm ODS	R448a/R449a	internal	-40°C / +10°C
5238175	LF5238175	RFKH11E-4.5-53	10201013402	3/8 sae - 12 mm ODS	R452a	external	-40°C / +10°C
5196390	LF5196390	RFKH11-4.5-56	10201013702	3/8 sae - 12 mm ODS	R452a	internal	-40°C / +10°C
3150154	750676	RFKH11-4.5-321	10201014002	3/8 sae - 12 mm ODS	R452a	internal	-40°C / -15°C
3150153	LF3150153	RFKH11E-4.5-324	10201014102	3/8 sae - 12 mm ODS	R452a	external	-40°C / -15°C
5193163	LF5193163	RFKH20E-4.3-78	10201024702	3/8 sae - 12 mm ODS	R455a/R454c	external	-40°C / +10°C
5193164	LF5193164	RFKH20-4.3-81	10201025002	3/8 sae - 12 mm ODS	R455a/R454c	internal	-40°C / +10°C

NOZZLES SANHUA SERIES H



REPA IT Code	REPA DE Code	Sanhua Code	Model
5238177	LF5238177	H0X	RFKH-023-0X
3150164	LF3150164	H00	RFKH-023-00
3150165	LF3150165	H01	RFKH-023-01
3150166	LF3150166	H02	RFKH-023-02
3150167	LF3150167	H03	RFKH-023-03
3150168	LF3150168	H04	RFKH-023-04
3150169	LF3150169	H05	RFKH-023-05
3150170	LF3150170	H06	RFKH-023-06

Valves

WELD ADAPTERS SANHUA



REPA IT Code	REPA DE Code	Sanhua code	Welding connection ODF mm
5238176	LF5238176	RFK-A04-038011	10
3150181	LF3150181	RFK-A04-038013	6

THERMOSTATIC VALVES SANHUA - R290



REPA IT Code	REPA DE Code	Model	Refrigerant gas	Equalisation of pressure	Working range
41675820	41675820	RFGB06-0.35-1694	R290	internal	-40°C / +10°C
3150226	LF3150226	RFGB06-0.35-522	R290	internal	-40°C / +10°C
3150227	LF3150227	RFGB06-0.7-1047	R290	internal	-40°C / +10°C
3150229	LF3150229	RFGB06E-0.35-523	R290	external	-40°C / +10°C
3150230	LF3150230	RFGB06E-0.7-433	R290	external	-40°C / +10°C
3150231	LF3150231	RFGB06E-1.0-470	R290	external	-40°C / +10°C

ELECTRONIC VALVES CAREL



REPA IT Code	REPA DE Code	Model	CAREL Code	Connection Inlet - Outlet	Refrigerant gas
3150210	LF3150210	E2V03Z	E2V03ZSF13	12 - 12 mm	HFC HFO CO2
3150209	LF3150209	E2V05Z	E2V05ZSF13	12 - 12 mm	HFC HFO CO2
3150208	LF3150208	E2V09Z	E2V09ZSF13	12 - 12 mm	HFC HFO CO2
3150207	LF3150207	E2V11Z	E2V11ZSF13	12 - 12 mm	HFC HFO CO2
3150205	LF3150205	E2V14Z	E2V14ZSF13	12 - 12 mm	HFC HFO CO2
3150206	LF3150206	E2V18Z	E2V18ZSF13	12 - 12 mm	HFC HFO CO2
3150204	LF3150204	E2V24Z	E2V24ZSF13	12 - 12 mm	HFC HFO CO2

ELECTRONIC VALVES CAREL - SPARE PARTS



Photo	REPA IT Code	REPA DE Code	Description	CAREL Code
1	3150211	LF3150211	COIL CAREL E2V/E2V B	E2VSTA0200
2	3150215	LF3150215	CABLE-CONNECTOR CAREL EXV 3m IP67	E2VCABS300
2	5109942	LF5109942	CABLE-CONNECTOR CAREL EXV 6m IP67	E2VCABS600
2	3150214	LF3150214	CABLE-CONNECTOR CAREL EXV 9m IP67	E2VCABS900
2	3150216	LF3150216	CABLE-CONNECTOR CAREL E2V 3m IP67	E2VCAB0300
2	3150212	LF3150212	CABLE-CONNECTOR CAREL E2V 6m IP67	E2VCAB0600

ELECTRONIC VALVES DANFOSS



REPA IT Code	REPA DE Code	Model	Connection Inlet - Outlet	Refrigerant gas
3150218	LF3150218	AKV 10P1	10 - 12 mm	HFCF HFC HFO CO2
3150219	LF3150219	AKV 10P2	10 - 12 mm	HFCF HFC HFO CO2
3150220	LF3150220	AKV 10P3	10 - 12 mm	HFCF HFC HFO CO2
3150221	LF3150221	AKV 10P4	10 - 12 mm	HFCF HFC HFO CO2
3150222	LF3150222	AKV 10P5	10 - 12 mm	HFCF HFC HFO CO2
5231169	10566122	AKV 10P6	10 - 12 mm	HFCF HFC HFO CO2

ELECTRONIC VALVES DANFOSS - SPARE PARTS



REPA IT Code	REPA DE Code	Description	Danfoss Code
3120748	LF3120748	Coil AKV 17W IP67	018F6732
3120208	LF3120208	Coil AKV 17W IP20	018F6193
3150223	LF3150223	Orifices for AKV valve (AKV 10P0 - P3)	068F5151
3150224	LF3150224	Orifices for AKV valve (AKV 10P4 - P8)	068F5152

Valves

ELECTRONIC VALVES SANHUA



REPA IT Code	REPA DE Code	Model	Connection Inlet - Outlet	Refrigerant gas
3150199	LF3150199	LPF08D-001	3/8" - 1/2"	HFCF HFC HFO CO2
3150194	LF3150194	LPF08D-003	10 -12 mm	HFCF HFC HFO CO2
3150196	LF3150196	LPF10D-002	3/8" - 1/2"	HFCF HFC HFO CO2
3150197	LF3150197	LPF10D-004	10 -12 mm	HFCF HFC HFO CO2
3150198	LF3150198	LPF14D-004	10 -12 mm	HFCF HFC HFO CO2
3150217	LF3150217	LPF18D-003	10 -12 mm	HFCF HFC HFO CO2
3150195	LF3150195	LPF24D-003	10 -12 mm	HFCF HFC HFO CO2

ELECTRONIC VALVES SANHUA - COMPLETE KIT



REPA IT Code	REPA DE Code	Description	Sanhua Code
3150202	LF3150202	SANHUA EEV VALVE KIT SEK10-02	SEK10-02
3150201	LF3150201	SANHUA EEV VALVE KIT SEK14-02	SEK14-02
3150203	LF3150203	SANHUA EEV VALVE KIT SEK18-02	SEK18-02
3150200	LF3150200	SANHUA EEV VALVE KIT SEK24-02	SEK24-02

Kits complete with electronic valve, coil, driver, pressure transducer, transducer cable and probe

ELECTRONIC VALVES SANHUA - SPARE PARTS



REPA IT Code	REPA DE Code	Description	Sanhua Code
3445650	LF3445650	DRIVER SANHUA SEC 612	SEC 612-R4
3397254	LF3397254	PRESSURE TRANSDUCER SANHUA YCQC2	YCQC02L18
3150213	LF3150213	CONNECTOR CABLE SANHUA YCQC02-013022	YCQC02-013022
3397255	LF3397255	TEMPERATURE PROBE SANHUA NTC2A1	NTC2A1
3120745	LF3120745	COIL SANHUA PQ-M24 1,5m	PQ-M24012-000007
3120747	LF3120747	COIL SANHUA PQ-M24 3m	PQ-M24012-000008
3120746	LF3120746	COIL SANHUA PQ-M24 6m	PQ-M24012-000009

Solenoid valves

SOLENOID VALVES CASTEL NC

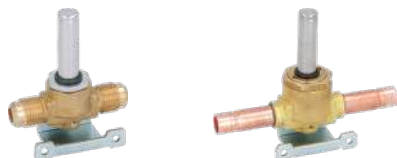

REPA IT Code	REPA DE Code	Model	Threaded connection SAE	ODF connection mm - in.	Operating principle	Kv factor m3/h	Hole mm	Length mm
3120921	370150	1020/2	1/4" MM	-	Direct action	0.175	2.5	58
3120156	370788	1020/3	3/8" MM	-	Direct action	0.23	3	65
3120157	370152	1064/3	3/8" MM	-	Diaphragm	0.80	7	68
3120159	370153	1070/4	1/2" MM	-	Diaphragm	2.20	12.5	100
3120169	LF3120169	1070/5	5/8" MM	-	Diaphragm	2.61	12.5	106
3120912	370151	1028/2	-	6 - 1/4"	Direct action	0.15	2.2	125
3120905	370382	1028/M10	-	10	Direct action	0.23	3	125
3120158	370383	1068/M10	-	10	Diaphragm	0.80	7	111
3120388	370864	1028/3	-	3/8"	Diaphragm	0.23	3	125
3120389	LF3120389	1068/3	-	3/8"	Diaphragm	0.80	7	111
3120168	370385	1078/M12	-	12	Diaphragm	2.20	12.5	127
3120390	LF3120390	1078/4	-	1/2"	Diaphragm	2.20	12.5	127
3120187	370386	1078/5	-	16 - 5/8"	Diaphragm	2.61	12.5	175

SOLENOID VALVES CASTEL NC FOR REFRIGERANTS HC (R290-R600a)



REPA IT Code	REPA DE Code	Model	ODF connection mm - in.	Operating principle	Kv factor m3/h
3120577	370804	1028N/2S	6 - 1/4"	Direct action	0.15
3120578	370805	1028V/2S.E	6 - 1/4"	Direct action	0.23

Solenoid valves

COILS AND CONNECTORS CASTEL



REPA IT Code	REPA DE Code	Coil type	Model	Volt	Hertz	Connection
3120188	371321	HF2	9300/RA2	24Vac	50/60	Terminal block PG9
3120189	371301	HF2	9300/RA4	110	50/60	Terminal block PG9
3120910	371337	HF2	9300/RA6	220/230	50/60	Terminal block PG9
5057408	371414	HF2	9300/RA7	240	50/60	Terminal block PG9
3120190	LF3120190	HF2	9300/RA8	380	50/60	Terminal block PG9
3120323	371084	CM2	9110/RA6	230	50/60	Cable with 3 wires
3120223	371304	PG9	9150/R01			

COILS AND CONNECTORS CASTEL FOR REFRIGERANT HC (R290-R600a)



REPA IT Code	REPA DE Code	Coil type	Model	Volt	Hertz	Connection
3120572	371338	HF2	9300EX/RA6	230	50/60	Terminal block PG9
3120573	LF3120573	PG9	9150EX/R02			

SOLENOID VALVES PARKER NC REFRIGERATION



REPA IT Code	REPA DE Code	Model	Threaded connection SAE	ODF connection mm - in.	Operating principle	Kv factor m ³ /h	Hole mm	Length mm
3120345	LF3120345	V3SM6	-	6	Direct action	0.185	2.5	102
3120212	LF3120212	V8F3	3/8" MM	-	Diaphragm	0.800	6.5	68
3120346	LF3120346	V8SM10	-	10	Diaphragm	0.80	6.5	106
3120218	LF3120218	V13F4	1/2" MM	-	Diaphragm	1.880	10	84
3120219	LF3120219	V13SM12	-	12	Diaphragm	1.880	10	127
3120221	LF3120221	V19SM16	-	16	Diaphragm	3.30	15	153

Solenoid valves

COILS AND CONNECTORS PARKER



REPA IT Code	REPA DE Code	Model	Volt	Hertz	Watt	Connection
1120362	371316	WB4.5	230	50/60	6	terminal block A-22
1199215	LF1199215	WB8.0	230	50/60	8	terminal block A-22
5037619	LF5037619	YB09	115	50/60	9	cable with 2 wires
1120361	371033	YB09	230	50/60	9	cable with 2 wires
3120606	LF3120606	YB14	24Vac	50/60	14	cable with 2 wires
3120917	371098	YB14	230	50/60	14	cable with 2 wires
3120032	371029	ZB09	230	50/60	9	terminal block B-32
4085847	371330	ZB15	230	50/60	15	terminal block B-32
3120222	371339	RT14	230	50/60	14	terminal block B-32
3120044	371091	A-22				
3120034	371090	B-32				

SOLENOID VALVES DANFOSS EVR NC



REPA IT Code	REPA DE Code	Model	Threaded connection SAE	ODF connection mm - in.	Kv factor m3/h	Hole mm	Length mm
3120613	370159	EVR3-032F8107	1/4"	6	0.27	3.3	75
3120338	370160	EVR3-032F1207		6	0.27	3.3	102
3120614	370161	EVR6-032L8072	3/8"	10	1	6.0	82
3120339	370287	EVR6-032L1213		10	0.80	6.0	111
3120675	370163	EVR10-032L8095	1/2"	12	1.90	10.0	103
3120616	370289	EVR10-032L1218		12	2.2	10.0	127
40016121	40016121	EVR2-032F1202		6	0.16	2.3	101
40016122	40016122	EVR2-032F8056	1/4"	6	0.16	2.3	75
40016123	40016123	EVR3-032F1204	3/8"		0.27	3.3	117
40016125	40016125	EVR3-032F1208		10	0.27	3.3	117
40016126	40016126	EVR3-032F204331	1/4"		0.27	3.3	101
40016127	40016127	EVR3-032F205331	6		0.27	3.3	101
40016128	40016128	EVR3-032F8116	3/8"	10	0.27	3.3	117
40016129	40016129	EVR6-032L1213		10	1	6	117
40016130	40016130	EVR6-032L1236		12	1	6	127
40016131	40016131	EVR10-032L1214	5/8"	16	2.2	10	163
40016132	40016132	EVR15-032L1225	7/8"		3.3	14	174

Solenoid valves

COILS AND CONNECTORS DANFOSS



REPA IT Code	REPA DE Code	Model	Volt	Hertz	Watt	Connection
3120246	LF3120246	042N4231	208-240	50/60	8	US 0.25 in Spade
3120607	LF3120607	018F7958	24	50/60	10	with cable (3 wire)
3120207	371004	018F6282	230	50/60	16	with cable (3 wire)
3120208	371293	018F6193	230	50/60	17	terminal block PG9
3120669	371040	018F6176	230	50	12	with terminal box
40016151	40016151	018F6701	230	50	11	terminal block
3120748	LF3120748	018F6732	230	50/60	17	terminal block
40016152	40016152	018F6707	24	50	12	terminal block
40016155	40016155	018F6801	230	50	13	terminal block
40016156	40016156	018F6887	24	50	20	terminal block

Compensations valves

COMPENSATION VALVES VA



REPA IT Code	REPA DE Code	Model	ø hole mm	Application
3526240	LF3526240	VA 180	20	vertical
3526241	LF3526241	VA 90	20	horizontal

Must be installed near a heat source

COMPENSATION VALVE



REPA IT Code	REPA DE Code	ø hole mm	Heating element	Extensible length mm	Max capacity
4092573	LF4092573	45	230V 6W	60-80-100-130	50m ³

COMPENSATION VALVES ELEBAR



REPA IT Code	REPA DE Code	Model	Heating element	ø hole mm
3150079	750334	MICROELEBAR		21
3526800	750332	MINIELEBAR TN		60
3150078	750330	MINIELEBAR BT Extensible	230V 7W	65
3526801	750327	ELEBAR TN		80
3526804	750328	ELEBAR BT	230V 7W	80

Filters

COPPER FILTERS



REPA IT Code	REPA DE Code	Length mm	Diameter mm	Molecular sieve g	Inlet ODF mm	Outlet ODF mm
7100514	750794	112	16	10	5.2	2.6
7100513	750793	112	16	10	6.5	2.6
7100515	LF7100515	114	16	10	6.5/4.5	2.3
3660001	LF3660001	120	19	15	5.2	2.6
3160239	750244	120	19	15	6.5	2.6
3660009	LF3660009	120	19	15	6.5	6.5
3660010	750616	125	19	15	6.5-6.5	2.5
7100512	LF7100512	141	19	20	5.2	2.6
3660002	750254	141	19	20	6.5	2.6
3660007	750617	130	24	25	6.5	2.5
3660008	750769	130	24	25	6.5	6.5
3160240	750619	140	24	30	6.5	2.6
5061764	750790	140	24	30	6.5	3.2
3160244	750276	140	24	30	6.5	6.5
3160241	750792	145	24	30	6.5-6.5	2.6
5038187	750047	145	24	30	6.5-6.5	6.5
3160401	750313	170	24	35	6.5-6.5	3.2
3660003	750791	170	24	40	6.5	2.5
4084078	750231	170	24	40	6.5	3.2
5038189	750232	170	24	40	6.5	6.5
3660005	LF3660005	190	24	50	6.5	2.5
3660004	LF3660004	190	24	50	6.2	6.2
3660006	LF3660006	190	24	50	8.5	8.5

DEHYDRATOR FILTERS WITH MOLECULAR SIEVE DENA



REPA IT Code	REPA DE Code	Model	International code	Threaded connection SAE	Length (mm)
3160269	LF3160269	MG111	032	1/4" MM	100
3160270	LF3160270	MG112	052	1/4" MM	115
3160271	LF3160271	MG213	082	1/4" MM	142
3160272	LF3160272	MG122	053	3/8" MM	125
3160273	LF3160273	MG223	083	3/8" MM	156
3160274	LF3160274	MG224	163	3/8" MM	168
3160275	LF3160275	MG233	084	1/2" MM	162
3160276	LF3160276	MG234	164	1/2" MM	174
3160278	LF3160278	MG345	305	5/8" MM	210

ANTI-ACID DEHYDRATOR FILTERS CASTEL



REPA IT Code	REPA DE Code	Model	International code	Threaded connection SAE	ODF connection mm - in	Nominal volume cm ³	Length mm
3160921	750082	4303/2F	-	1/4" FM		50	92
3160246	750426	4305/2F	-	1/4" FM		80	109
3660016	LF3660016	4308/2F	-	1/4" FM		130	135
3160922	750083	4308/3F	-	3/8" FM		130	135
5168023	750040	DF303/2	032	1/4" MM		50	103
3660102	750038	DF303/2S	032S		6-1/4"	50	94
5124238	750041	DF305/2	052	1/4" MM		80	119
3660103	750039	DF305/2S	052S		6-1/4"	80	110
3660093	10625003	DF308/2	082	1/4" MM		130	146
3660095	750079	DF316/2	162	1/4" MM		250	158
3660089	750427	DF303/3	033	3/8" MM		50	111
5124240	750042	DF305/3	053	3/8" MM		80	127
3660094	10625006	DF308/3	083	3/8" MM		130	154
3660096	750046	DF316/3	163	3/8" MM		250	166
3660097	750081	DF316/4	164	1/2" MM		250	174
3160923	750084	4316/5	165	5/8" MM		250	183
3160552	LF3160552	DF330/4	304	1/2" MM		500	249
3160550	LF3160550	DF330/5	305	5/8" MM		500	259

ANTI-ACID DEHYDRATOR FILTERS CASTEL FOR REFRIGERANTS HC (R290-R600a)



REPA IT Code	REPA DE Code	Model	International code	ODF connection mm - in	Nominal volume cm ³	Length mm
3160540	750562	4303EX/2S	032S	6 - 1/4"	50	94

Filters

REFRIGERATION FILTERS WITH HUMIDITY INDICATOR



REPA IT Code	REPA DE Code	Model	CASTEL Code	SAE connection	ODS connection	Diameter mm	Length mm
3660018	LF3660018	DI305N/2	052	1/4"		64	155
3660019	LF3660019	DI305N/2S	052S		1/4"	64	166
3660020	LF3660020	DI305N/3	053	3/8"		64	165
3660023	LF3660023	DI305N/3S	053S		3/8"	64	169
3660024	LF3660024	DI305N/M10S			10 mm	64	171
5148854	LF5148854	DI308N/2	082	1/4"		64	176
3660025	LF3660025	DI308N/2S	082S		1/4"	64	187
3660026	LF3660026	DI308N/3	083	3/8"		64	186
3660027	LF3660027	DI308N/3S	083S		3/8"	64	190
3660028	LF3660028	DI308N/M10S			10 mm	64	192
3660029	LF3660029	DI308N/M12S			12 mm	64	196
3660030	LF3660030	DI308N/4	084	1/2"		64	191
3660031	LF3660031	DI308N/4S	084S		1/2"	64	194
3660032	LF3660032	DI316N/3	163	3/8"		64	206
3660033	LF3660033	DI316N/3S	163S		3/8"	64	210
3660034	LF3660034	DI316N/M10S			10 mm	64	212
3660035	LF3660035	DI316N/M12S			12 mm	64	216
3660021	LF3660021	DI316N/4	164	1/2"		64	211
3660022	LF3660022	DI316N/4S	164S		1/2"	64	214
3660036	LF3660036	DI316N/5	165	5/8"		64	221
3660037	LF3660037	DI316N/5S	165S		5/8" 16 mm	64	222
3660038	LF3660038	DI330N/4S	304S		1/2"	76	286
3660039	LF3660039	DI330N/5	305	5/8"		76	293
3660040	LF3660040	DI330N/5S	305S		5/8" 16 mm	76	293,5
3660041	LF3660041	DI330N/6	306	3/4"		76	319
3660042	LF3660042	DI330N/6S	306S		3/4"	76	316
3660043	LF3660043	DI330N/7S	307S		7/8"	76	321
3660044	LF3660044	DI341N/4S	414S		1/2"	89	290
3660045	LF3660045	DI341N/5	415	5/8"		89	297
3660046	LF3660046	DI341N/5S	415S		5/8" 16 mm	89	297,5
3660047	LF3660047	DI341N/6	416	3/4"		89	323
3660048	LF3660048	DI341N/7S	417S		7/8"	89	325

ANTI-ACID DEHYDRATOR FILTERS DANFOSS



REPA IT Code	REPA DE Code	Model	International Code	Threaded connection SAE	ODF connection	Nominal volume cm ³	Length mm
3160496	750037	DCL 032	032	1/4"	-	51	110
3160497	750664	DCL 052	052	1/4"	-	85	119
3660017	750032	DML 052	052	1/4"	-	85	119
3660011	750672	DCL 052S	052S	-	1/4"	85	107
3160328	750034	DCL 082	082	1/4"	-	114	145
3660012	750671	DCL 082S	082S	-	1/4"	114	133
3160374	750428	DCL 162	162	1/4"	-	226	154
3160549	750663	DCL 053	053	3/8"	-	85	132
3160373	750035	DCL 083	083	3/8"	-	114	158
3660013	750670	DCL 083S	083S	-	10 mm	114	139
3160375	750665	DCL 163	163	3/8"	-	226	167
3660014	LF3660014	DCL 163S	163S	-	10 mm	226	148
3160376	750429	DCL 164	164	1/2"	-	226	175
3660015	LF3660015	DCL 164S	164S	-	12 mm	226	152
40016134	40016134	DML 032	032	1/4"	6 mm	51	110
40016135	40016135	DML 032S	032S	-	1/4"	51	98
40016136	40016136	DML 033	033	3/8"	10 mm	51	123
5114066	750033	DML 053	053	3/8"	10 mm	85	132
40016137	40016137	DML 053S	053S	-	10 mm	85	113
40016138	40016138	DML 082	082	1/4"	6 mm	114	145
40016139	40016139	DML 083	083	3/8"	10 mm	114	158
40016140	40016140	DML 083S	083S	-	3/8"	114	139
40016141	40016141	DML 083S	083S	-	10 mm	114	139
40016142	40016142	DML 084	084	1/2"	12 mm	114	166
40016143	40016143	DML 084S	084S	-	12 mm	114	143
40016144	40016144	DML 162	162	1/4"	6 mm	226	154
40016145	40016145	DML 163	163	3/8"	10 mm	226	167
40016146	40016146	DML 164	164	1/2"	12 mm	226	175
40016147	40016147	DML 165	165	5/8"	16 mm	226	184
40016148	40016148	DML 165S	165S	-	5/8"	226	160
40016149	40016149	DML 305	305	5/8"	16 mm	464	260

ANTI-ACID DEHYDRATOR FILTERS DANFOSS DOUBLEFLOW



REPA IT Code	REPA DE Code	Model	International code	Threaded connection SAE	ODF connection	Nominal volume cm ³	Length mm
3160381	LF3160381	DCB083S	083S	-	3/8" in	80	141

Filters

ANTI-ACID DEHYDRATOR FILTERS WITH PARKER INDICATOR



REPA IT Code	REPA DE Code	Model	Threaded connection SAE	Length mm
3160306	LF3160306	PRSG052	1/4" MM	131
3160307	750800	PRSG082	1/4" MM	163
3160308	LF3160308	PRSG083	3/8" MM	192
3160309	LF3160309	PRSG164	1/2" MM	198

BI-FLOW FILTER DRIERS SANHUA



REPA IT Code	REPA DE Code	Model	Sanhua Code	Type	ODF connection	Volume cm ³	Length mm
3660062	LF3660062	STGB 052s	STG-B05020-901	SOLDER	1/4"	82	76
3660063	LF3660063	STGB 052s	STG-B05061-901	SOLDER	6mm	82	76
3660064	LF3660064	STGB 053s	STG-B05101-901	SOLDER	10mm	82	76
3660065	LF3660065	STGB 083s	STG-B08030-901	SOLDER	3/8"	131	98
3660066	LF3660066	STGB 083s	STG-B08101-901	SOLDER	10mm	131	98
3660067	LF3660067	STGB 084s	STG-B08121-901	SOLDER	12mm	131	98
3660068	LF3660068	STGB 163s	STG-B16030-901	SOLDER	3/8"	262	118
3660069	LF3660069	STGB 164s	STG-B16040-901	SOLDER	1/2"	262	118
3660070	LF3660070	STGB 165s	STG-B16050-901	SOLDER	5/8" - 16mm	262	118
3660071	LF3660071	STGB 164s	STG-B16121-901	SOLDER	12mm	262	118
3660072	LF3660072	STGB 305s	STG-B30050-901	SOLDER	5/8" - 16mm	492	193
3660073	LF3660073	STGB 307s	STG-B30070-901	SOLDER	7/8" - 22mm	492	193
3660074	LF3660074	STGB 304s	STG-B30121-901	SOLDER	12mm	492	193

MOISTURE INDICATORS CASTEL



3910/...



REPA IT Code	REPA DE Code	Model	Threaded connection SAE	ODF connection mm - in.	Length mm
3201024	750060	3910/22	1/4" MM	-	71.5
3201025	LF3201025	3910/33	3/8" MM	-	77.5
3201026	750424	3910/44	1/2" MM	-	81.5
3201014	750070	3950/22	1/4" FM	-	68
3201015	750008	3950/33	3/8" FM	-	74
3201016	750072	3950/44	1/2" FM	-	77
3201017	750415	3950/55	5/8" FM	-	84
3201019	750417	3940/2	-	6 - 1/4"	133
3201020	750418	3940/M10	-	10	117
3201039	750419	3940/3	-	3/8"	117
3201021	750420	3940/M12	-	12	117
3201040	750421	3940/4	-	1/2"	117
3201023	750423	3940/M18	-	18	131

MOISTURE INDICATORS DANFOSS

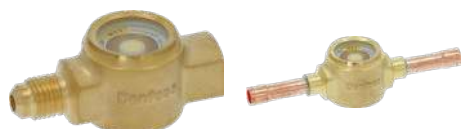

REPA IT Code	REPA DE Code	Model	Threaded connection SAE	ODF connection mm	Length mm
3221466	750412	SGN6	1/4" FM	-	67
3221467	750413	SGN10	3/8" FM	-	82
3221464	750414	SGN6S	-	6	101
3221465	750066	SGN10S	-	10	119
3101002	LF3101002	SGN12	1/2" FM	-	88
3101001	LF3101001	SGN12S	-	12	146

Filters

HUMIDITY INDICATORS SANHUA



REPA IT Code	REPA DE Code	Model	Threaded connection SAE	ODF connection
3101003	LF3101003	SYJ6	-	6mm
3101007	LF3101007	SYJ6	1/4" FM	-
3101004	LF3101004	SYJ10	-	10mm
3101008	LF3101008	SYJ10	3/8" FM	-
3101005	LF3101005	SYJ12	-	12mm
3101006	LF3101006	SYJ16	-	16mm - 5/8"

Thermostats

THERMOSTATS RANCO SERIES K VARIFIX



RANCO

REPA IT Code	REPA DE Code	Model	Warm	Capillary length mm	Used for	Cold
D444072	391054	K50 P1110	+2°C	1200	Refrigerators	-14.5/-23.5°C
3444918	390545	K50 P1125	+8.5°C	1200	Refrigerators	-9.5/-18°C
3444887	LF3444887	K60 P1013	-4/-10°C	1200	Refrigerators with manual defrost	-25°C
D444075	391056	K54 P1102	-12/-16.5°C	2000	Freezers active signal	-34°C
3444956	390272	K50 P1117	-12/-16.5°C	2000	Freezers without signal	-34°C
D444068	391064	K59 L1102	+3.5/-11°C	1200	Refrigerators with automatic defrost	+3.5/-26°C
3444919	390285	K50 P1115	+11°C	2000	Liquid / bottle coolers	+4/+1.5°C
3444819	LF3444819	K50 P1118	+12.5°C	1200	Liquid / bottle coolers	+2/-3°C

THERMOSTATS



1



2



3



4



5

Photo	REPA IT Code	REPA DE Code	Range	Capillary length mm
1	3744129	390012	-35/+35°C	1500
2	3744130	390011	-35/+35°C	-
3	3744231	390674	0/+40°C	1500
4	3744229	390010	-35/+35°C	1500
5	3744230	390673	0/+40°C	1500

Thermostats

THERMOSTATS PRODIGY



PRODIGY
Italiana

REPA IT Code	REPA DE Code	Model	Range	Capillary length mm
3444993	390536	F2000	-35/+35°C	1500
3444976	390537	F2000	0/+40°C	1500
3444800	LF3444800	F2000	0/+60°C	1500
3444801	390595	F2000	+30/+90°C	1500
3444799	390952	F2000	+30/+120°C	1500
3444996	390538	2000A	-35/+35°C	-
3444977	LF3444977	2000A	0/+40°C	-
3444172	390534	TR711N	-35/+35°C	1500
3744235	390535	TR711N	0/+40°C	1500

THERMOSTATS ARTHERMO



ARTHERMO®

REPA IT Code	REPA DE Code	Model	Range	Capillary mm
3744127	LF3744127	ARTH093	-35..+35°C	1500
3744128	LF3744128	ARTH094	-35..+35°C	
3744131	LF3744131	ARTH096	0..40°C	1500
3744132	LF3744132	ARTH095	0..40°C	

THERMOSTATS ARTHERMO



ARTHERMO®

REPA IT Code	REPA DE Code	Model	Range	Capillary mm
3444989	391082	TR2	-35..+35°C	1500
3444987	LF3444987	TSC 093C	-35..+35°C	1500
3444988	LF3444988	TSC 094C	-35..+35°C	
3444986	LF3444986	TSC 093C+24W	-35..+35°C	1000

Thermostats

THERMOSTATS DANFOSS SERVICE KIT



REPA IT Code	REPA DE Code	Model	Warm	Cold	Capillary length mm	Used for
3444879	390552	077B-7001	+2/-5.5°C	1300	Refrigerators	-13.5/-25°C
3444880	390553	077B-7002	+0/-7.5°C	1300	Refrigerators with manual defrost	-12/-22°C
3444881	390554	077B-7003	+3.5/-11°C	1600	Refrigerators with automatic defrost	+3.5/-27.5°C
3444882	390555	077B-7004	+3.5/-1°C	1600	Absorption coolers	-5.5/-11°C
3444883	390556	077B-7005	-7.8/-15°C	2300	Freezers without signal	-21/-32.5°C
3444951	390557	077B-7006	-10/-17°C	2300	Freezers active signal	-24/-34.5°C
3444884	390558	077B-7007	-10/-17°C	2300	Freezers passive signal	-24/-34.5°C
3444533	390559	077B-7008	+11.5/+6°C	2000	Liquid / bottle coolers	-1/-8.5°C
3444541	390677	077B-0028	+10.5/+5°C	1200	Liquid / bottle coolers	+3/-4.5°C

THERMOSTATS DANFOSS KP



REPA IT Code	REPA DE Code	Model	Calibration range	Bulb type	Reset	Differential
3744103	390487	KP61-060L1128	-30..+13°C	A	aut w/hand switch	2..10°C
3744163	LF3744163	KP61-060L1182	-30..+13°C	A	aut	2..10°C
3444890	390494	KP62-060L1110	-30..+15°C	B	aut w/hand switch	2..10°C
3444544	390491	KP71-060L1115	-5..+20°C	C	man	-
3444895	390490	KP71-060L1113	-5..+20°C	C	aut	2..10°C

Telethermometers

TELETHERMOMETERS 11x62 mm



REPA IT Code	REPA DE Code	Model	Colour	Bulb	Temperature range	Capillary mm
3441079	541414	CEWAL TRR 62.11	White	ø 8.5x20 mm	-40..+40°C	1500

TELETHERMOMETERS 58x25 mm



Photo	REPA IT Code	REPA DE Code	Brand	Colour	Model	Bulb	Temperature range	Capillary mm
1	3441090	LF3441090	ARTHERMO	Black	ROF-88	ø 8.4x25 mm	-30..+40°C	1500
1	3441001	541080	ARTHERMO	Black	ROF-88	ø 8.4x25 mm	-40..+40°C	2500
2	3441913	541191	ARTHERMO	Black	ROF-88	ø 6x60 mm	-40..+40°C	2500
2	3441078	LF3441078	ARTHERMO	Black	ROF-88	ø 6x30 mm	-40..+40°C	2000
2	3441081	541081	CEWAL	White	TR58.25 P	ø 8.4x20 mm	-40..+40°C	1000
2	3441082	LF3441082	WIKA	White		ø 8.5x29 mm	-40..+40°C	700

TELETHERMOMETERS ø 52 mm



Photo	REPA IT Code	REPA DE Code	Bulb	Temperature range	Capillary mm
1	3441901	542479	ø 6x50 mm	-40..+40°C	1500
2	3441002	LF3441002	ø 7,5x40 mm	-40..+40°C	2500
3	3441077	LF3441077	ø 6x50 mm	-40..+40°C	1500

Telethermometers

TELETHERMOMETERS ø 60 mm



Photo	REPA IT Code	REPA DE Code	Bulb	Temperature range	Capillary mm
1	3441003	541082	ø 6x150 mm	-40..+40°C	2000

TELETHERMOMETERS F87R WITH REVERSIBLE FLANGE



ARTHERMO®

REPA IT Code	REPA DE Code	Body diameter mm	Bulb	Temperature range	Capillary mm
3441931	542489	60	ø 7.5x30 mm	-40..+40°C	1500
3441932	LF3441932	80	ø 7.5x30 mm	-40..+40°C	1500
3441933	LF3441933	100	ø 7.5x30 mm	-40..+40°C	1500

Evaporators LUVE SHS

EVAPORATORS LUVE SHS



REPA IT Code	REPA DE Code	Model	Length	Axial fan no. x ø mm	Refrigeration power Watt DT1=10K	Fin spacing mm
3123199	LF3123199	EVAPORATOR LUVE SHS 8	493mm	1 x 230mm	700	5
3123201	LF3123201	EVAPORATOR LUVE SHS13	647mm	1 x 230mm	950	5
3123202	LF3123202	EVAPORATOR LUVE SHS22	803mm	2 x 230mm	1570	5
3123203	LF3123203	EVAPORATOR LUVE SHS26	1126mm	2 x 230mm	2050	5
3123204	LF3123204	EVAPORATOR LUVE SHS32	1126mm	3 x 230mm	2290	5

Evaporators for counters

VENTILATED EVAPORATORS FOR COUNTER



REPA IT Code	REPA DE Code	Model	Dimensions mm LxDxH	Axial fan no. x ø mm	Refrigeration power Watt DT1=8K
3123019	750778	EVC1N	400x83x365	2x120	312
3123020	750779	EVC2N	400x83x415	2x120	384
3123021	LF3123021	EVC3N	400x83x465	2x120	432
3123022	LF3123022	EVC4N	400x83x515	2x120	480
3123023	750781	EVP1N	400x83x365	2x120	312
3123024	750780	EVP2N	400x83x415	2x120	384

EVC = Central version for counters EVP = Wall mounted version for counters and cabinets

Condensers

COUNTERFLOW WATER COOLED CONDENSERS



REPA IT Code	REPA DE Code	Model	Dimensions mm LxDxH	Refrigeration power Watt DT1=15K	Gas pipe ø mm	Water pipe ø mm
3123061	750798	CHS1	110x135x180	1000	6	10
3123060	LF3123060	CHS2	130x160x220	2000	8	10
3123062	LF3123062	CHS3	162x200x220	3000	8	10
3123063	LF3123063	CHS4	180x240x225	4000	10	12

AIR COOLED CONDENSERS LU-VE



REPA IT Code	REPA DE Code	Model	Dimensions mm LxDxH	Refrigeration power Watt DT1=15K	Fan diameter no. x ø mm	Surface m ²	Conveyors of plastic
5021793	LF5021793		140x60x185	655			
3123093	LF3123093	STFT 12118	190x30x185	470	1x170	0.55	CF18
3123088	LF3123088	STFT 12218	190x60x185	745	1x170	1.1	CF18
3123092	LF3123092	STFT 14121	220x30x215	665	1x200	0.75	CF21
3123089	750797	STFT 14221	220x60x215	1000	1x200	1.5	CF21
3123125	LF3123125	STFT 16124	250x30x245	925	1x230	1	CF24
3123090	750409	STFT 16224	250x60x245	1385	1x230	2	CF24
3068901	750249	STN 8324	290x90x245	1125	1x230	2.66	C24
3123091	LF3123091	STFT 18227	280x60x275	1935	1x254	2.5	CF27

CONVEYORS OF PLASTIC



REPA IT Code	REPA DE Code	Model
3123094	LF3123094	CF18
3123095	LF3123095	CF21
3123096	LF3123096	CF24
3123097	LF123097	CF27

Condensers

AIR COOLED CONDENSERS



REPA IT Code	REPA DE Code	Model	Dimensions mm LxDxH	Refrigeration power Watt DT1=15K	Fan diameter no. x ø mm	Fin spacing mm
3030005	LF3030005	CCV1024/3	300x130x256	1170	1x230	3.6
3123064	LF3123064	CCV1024/4	300x130x256	1740	1x230	3.6
3123006	LF3123006	CCV1127/4	320x135x280	1930	1x250	3.6
3123009	LF3123009	CCV1438/4	410x165x355	3539	1x300	3.6
3123010	LF3123010	CCV1643/4	520x162x415	5810	1x350	3.2
3123011	LF3123011	CCV1258/3	650x140x308	4380	2x250	3.2
3123012	LF3123012	CCV1258/4	650x160x308	5240	2x250	3.2
3123014	LF3123014	CCV1470/4	780x185x360	7500	2x300	3.2
3123015	LF3123015	CCV1682/4	908x173x420	10050	2x350	3.2

FAN-COOLED CONDENSERS LU-VE



REPA IT Code	REPA DE Code	Model	Dimensions mm LxDxH	Refrigeration power Watt DT1=15K	Fan diameter no. x ø mm
5243855	LF5243855	CAVF 113	300x150x276h	1315	1x254
5243856	LF5243856	CAVF 93	270x147x245h	1275	1x230
5243857	LF5243857	CAVF 83	240x141,5x215h	675	1x200
5243858	LF5243858	CAVF 73	210x141,5x185h	770	1x170

Heating elements

CARTRIDGE HEATING ELEMENTS PTC UNIVERSAL



REPA IT Code	REPA DE Code	Power supply	Cartridge length mm	ø mm	Evaporation capacity	Power	Power in absence of water	Coupling	Cable length mm
3455466	417570	230V	120	12	0.11 Kg/h	110W	10W	3/8"G	1000
3455467	417571	230V	180	12	0.2 Kg/h	230W	20W	3/8"G	1000
3455468	417572	230V	240	12	0.3 Kg/h	330W	30W	3/8"G	1000

HEATING ELEMENTS CARTER



REPA IT Code	REPA DE Code	Power supply	Power	ø min. mm	ø max. mm
3455469	696599	230V	35W	110	180
3455470	696600	230V	45W	150	290
3455476	696601	230V	65W	210	330

HEATING ELEMENTS ETCHED FOIL IN SILICONE



REPA IT Code	REPA DE Code	Power supply	Power	Dimension mm	Thermostat
3355661	416315	230V	80W	470x65	100°C
3355689	418855	230V	100W	210x60	130°C
3355688	418856	230V	200W	210x117	130°C
5039574	419331	230V	700W	290x300	

with adhesive side

HEATING ELEMENTS WITH METAL MESH



Photo	REPA IT Code	REPA DE Code	Hot zone length mm	Cable length mm	Volt	Watt	Braiding coat	Max. temperature (°C)
4	3355916	418755	3330	1000+1000	230V	100	CuSt	120
5	3355974	LF3355974	3500	2700+2700	230V	100	CuSt	120
1	3355968	LF3355968	4200	600+600	230V	42	Fiberglass	110
1	3355969	LF3355969	4480	1000+1000	230V	44.8	Fiberglass	110
3	3355955	418592	4400	1900+1900	230V	52	CuSt	120
6	3355970	416747	4600	1000+1000	230V	46	CuSt	120
4	3355919	419109	4700	1150+1150	230V	150	CuSt	120
3	3355956	418591	5500	1900+1900	230V	68	CuSt	120
1	3355973	LF3355973	6400	600+600	230V	64	Fiberglass	110

HEATING ELEMENTS IN SILICONE



REPA IT Code	REPA DE Code	Hot zone length mm	Cable length mm	Volt	Watt	Silicone insulation ø (mm)
3355684	418807	1210	1755+1755	230	18	3
3355690	LF3355690	2300	300+300	230	45	3
3355683	418809	2680	1740+1740	230	41	3
3355698	420372	3000	500+500	230	54	3
3355699	LF3355699	3500	500+500	230	63	3
3355700	420373	4000	500+500	230	72	3
3355705	LF3355705	4500	500+500	230	81	3
3355706	420374	5000	500+500	230	90	3
3355728	LF3355728	5500	500+500	230	99	3
3355932	416311	6000	800+800	230	46	3
3355729	420375	6000	500+500	230	108	3
3355730	417805	6500	500+500	230	117	3
3355734	420376	7000	500+500	230	126	3
3355735	LF3355735	7500	500+500	230	135	3
3355738	420377	8000	500+500	230	144	3

Heating elements

HEATING ELEMENTS IN SILICONE FOR CONDENSATE DRAIN



REPA IT Code	REPA DE Code	Hot zone length mm	Cable length mm	Volt	Watt
3356180	416336	500	2400	230	16
3355967	419345	970	1500	230	30
3455043	LF3455043	1000	500	230	20
3355941	417518	1000	1000	230	50
3355964	LF3355964	1870	1300	230	28,8
3355942	417519	2000	1000	230	100
3355943	417520	3000	1000	230	150
3355944	417521	4000	1000	230	200
3355945	417522	5000	1000	230	250
3355946	417523	6000	1000	230	300

HEATING ELEMENTS FOR AIR EVAPORATORS LU-VE SHP



REPA IT Code	REPA DE Code	Model	Power Watt	Length mm	Width mm
3455430	LF3455430	RCE 051	250	345	50
3455431	LF3455431	RCE 061	500	630	50

HEATING ELEMENTS SHEATHED, TUBULAR, FLEXIBLE

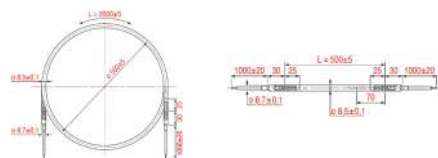

REPA IT Code	REPA DE Code	Model	Length A mm	Hot zone length mm	Watt
3455432	LF3455432	RSV-050	500	486	150
3455433	LF3455433	RSV-060	600	586	200
3455434	LF3455434	RSV-100	1000	860	350
3455435	LF3455435	RSV-125	1250	1110	450
3455436	LF3455436	RSV-150	1500	1360	550
3455437	LF3455437	RSV-175	1750	1610	600
3455438	LF3455438	RSV-200	2000	1860	700
3455439	LF3455439	RSV-225	2250	2110	800
3455440	LF3455440	RSV-250	2500	2360	900
3455441	LF3455441	RSV-275	2750	2610	1000
3455442	LF3455442	RSV-300	3000	2860	1100
3455443	LF3455443	RSV-325	3250	3110	1200
3455444	LF3455444	RSV-350	3500	3360	1300
3455455	LF3455455	RSV-375	3750	3610	1400
3455445	LF3455445	RSV-400	4000	3860	1500
3455446	LF3455446	RSV-450	4500	4360	1700
3455447	LF3455447	RSV-500	5000	4860	1900
3455450	LF3455450	RSV-650	6500	6360	2400

Drip trays

CONDENSATE EVAPORATION TRAYS UNIVERSAL



REPA IT Code	REPA DE Code	Capacity	Dimensions mm	Features	Photo
3015079	750430	1.65 L	294x35xh200	vertical	1
3015080	LF3015080	1.5 L	325x200xh35	horizontal	2
3016004	750431	2.8 L	300x140xh100	horizontal	3

with hole for cartridge element PTC(fitting 3/8"G)

CONDENSATE EVAPORATION TRAYS



REPA IT Code	REPA DE Code	Model	Capacity	Volt	W	A	Evaporating capacity	Dimensions	Features
3016011	750001	BDE/16	1.5 l	230	160	0.7	2.3 l/day	315x120 mm	
3016007	750002	BDE/30	1.5 l	230	300	1.3	4.5 l/day	315x120 mm	
3015042	750807	D70	1.5 l	230	300	1.3	4.5 l/day	315x120 mm	with PTC control

Potentiometers

SPEED REGULATORS FOR FANS DIXELL



REPA IT Code	REPA DE Code	Model	Power supply	Action	Inlet	Triac outlet	Calibration range	Differential
3240688	LF3240688	XV105D-50DN0	230V 50Hz	Direct	NTC probe	250V max 500W	0..60°C	1..30°C

SPEED REGULATORS FOR FANS ELIWELL



REPA IT Code	REPA DE Code	Model	Power supply	Inlet	Triac outlet	Calibration range	Description
3445075	402946	FASEC 33	230V 50/60Hz	1-PTC probe	n.1-2.5A	0..60°C	for condenser fan
3351154	380137	OCTAL ES8					base
3445063	LF3445063	PTC PROBE					for tube mounting

Pressure switches

PRESSURE SWITCHES JOHNSON CONTROLS P100



REPA IT Code	REPA DE Code	Model	Low pressure	High pressure	Reset	Threaded connection	ODF connection	Cable length
3320139	542285	P100AP-306D	2.8 In - 0.3 Out	-	aut	1/4" F	-	2000
3320137	LF3320137	P100CP-102D	-	11 In - 16 Out	aut	1/4" F	-	2000
3320140	LF3320140	P100CP-104D	-	18 In - 24 Out	aut	1/4" F	-	2000
3320138	LF3320138	P100CP-106D	-	23 In - 28 Out	aut	1/4" F	-	2000
3320261	LF3320261	P100CP-107D	-	23 In - 28 Out	aut	-	6	2000

PRESSURE SWITCHES DANFOSS SERIES ACB



REPA IT Code	REPA DE Code	Model	Pressure bar	Reset	Features
5078675	542487	ACB-2UA428W	10 In - 9 Out	aut	solder connection with wires (1)
3320152	542133	ACB-2UA574W	11.5 In - 8.5 Out	aut	solder connection with wires (1)
3320252	LF3320252	ACB-2UB131W	22 In - 29 Out	aut	flare connection with wires (3)
5038870	LF5038870	ACB-2UB178	24 In - 33 Out	aut	solder connection with spade (2)
3320151	542132	ACB-2UA459W	16 In - 19 Out	aut	solder connection with wires

PRESSURE SWITCHES RANCO SERIES NSD



REPA IT Code	REPA DE Code	Model	Pressure bar	Reset	Features
3320131	LF3320131	NSDHA00D39105	27-22	aut	flare connection 1/4" sae F with 3 wires (c-no-nc)

PRESSURE SWITCHES AND MINI-PRESSURE SWITCHES ROBERTSHAW RANCO



REPA IT Code	REPA DE Code	Model	Low pressure bar	High pressure bar	Reset	Connections	Features
3320270	LF3320270	O17-R4701 Dual Heavy Duty Pressure Controls	-0.3 bar - 7 bar	6 bar - 32 bar	automatic	1/4" SAE	
3320271	LF3320271	O17-R4705 Dual Heavy Duty Pressure Controls	-0.3 bar - 7 bar	6 bar - 32 bar	LP auto / HP manual	1/4" SAE	
3320272	LF3320272	O17-R4758 Dual Heavy Duty Pressure Controls	-0.3 bar - 7 bar	6 bar - 32 bar	automatic	1/4" SAE	PED
3320273	LF3320273	O17-R4759 Dual Heavy Duty Pressure Controls	-0.3 bar - 7 bar	6 bar - 32 bar	LP auto / HP manual	1/4" SAE	PED
3320278	LF3320278	O16-R6703 Single Heavy Duty Low Pressure Control	-0.3 bar - 7 bar		automatic	1/4" SAE	
5157973	LF5157973	O16-R6705 Single Heavy Duty Low Pressure Control	-0.3 bar - 7 bar		manual	1/4" SAE	
3320281	LF3320281	O16-R6750 Single Heavy Duty High Pressure Control		6 bar - 32 bar	automatic	1/4" SAE	
3320282	LF3320282	O16-R6751 Single Heavy Duty High Pressure Control		6 bar - 32 bar	manual	1/4" SAE	
3320283	LF3320283	O16-R6758 Single Heavy Duty High Pressure Control		6 bar - 32 bar	automatic	1/4" SAE	PED
3320289	LF3320289	LPS-06-18 Mini Low Pressure switch	0.6 bar		automatic	1/4" FEMALE FLARE	1m WIRE
3320290	LF3320290	LPS-17-34 Mini Low Pressure switch	1.7 bar		automatic	1/4" FEMALE FLARE	1m WIRE
3320291	LF3320291	LPS-38-59 Mini Low Pressure switch	3.8 bar		automatic	1/4" FEMALE FLARE	1m WIRE
3320292	LF3320292	LPS-69-90 Mini Low Pressure switch	6.9 bar		automatic	1/4" FEMALE FLARE	1m WIRE
3320293	LF3320293	HPS-18-13 Mini High Pressure Switch		18 bar	automatic	1/4" FEMALE FLARE	1m WIRE
3320294	LF3320294	HPS-26-20 Mini High Pressure Switch		26 bar	automatic	1/4" FEMALE FLARE	1m WIRE
3320280	LF3320280	HPS-28-21 Mini High Pressure Switch		28 bar	automatic	1/4" FEMALE FLARE	1m WIRE
3320295	LF3320295	HPS-32-24 Mini High Pressure Switch		32 bar	automatic	1/4" FEMALE FLARE	1m WIRE

Pressure switches

PRESSURE SWITCHES DANFOSS SERIES KP



REPA IT Code	REPA DE Code	Model	Low pressure	High pressure	Differential	Reset	Features
3320184	541464	KP1 060-1101	-0.2..7.5		0.7..4	aut	PED
3320253	LF3320253	KP5 060-5133		8..32	3	man	
3320200	541462	KP5 060-5096		8..32	1.8..6	aut	
3320254	541467	KP7W 060-1190		8..32	4..10	aut	PED
3320255	542468	KP15 060-5071	-0.2..7.5	8..32	4 High - 0.7.4 Low	aut	
3320256	541469	KP17W 060-1275	-0.2..7.5	8..32	4 High - 0.7.4 Low	aut	PED
5191162	S2005740	KP5 060-117166		8..32	1.8..6	aut	
40016113	40016113	KP17W 060-127566	-0.2..7.5	8..32	0.7..4	aut	
40016114	40016114	KP17WB 060-539766	0.7..4	8..32	0.7..4	aut	

BRACKETS FOR PRESSURE SWITCHES



REPA IT Code	REPA DE Code	Description
3320906	LF3320906	elbow bracket

Refrigerant leaks detections

REFRIGERATION TOOLS - GAS DETECTORS



REPA IT Code	REPA DE Code	Brand	Description	Power supply	Refrigerants
41099566	41099566	ELIWELL	LEAK DETECTOR LKDNNext CO2	24V	R744 (CO2)
41099567	41099567	ELIWELL	SPARE SENSOR LKDNNext CO2		
41099568	41099568	ELIWELL	LEAK DETECTOR LKDNNext R32MIX	24V	R32-R407a-R410a-R452a
41099569	41099569	ELIWELL	SPARE SENSOR LKDNNext R32MIX		
41099570	41099570	ELIWELL	LEAK DETECTOR LKDNNext HFC/HFO	24V	R22-R134a-R404a
41099571	41099571	ELIWELL	SPARE SENSOR LKDNNext HFC/HFO		
5243554	LF5243554	TECNOCONTROL	LEAK DETECTOR SE237PX	230V	R290
5243555	LF5243555	TECNOCONTROL	CARTRIDGE FOR LEAK DETECTOR SE237PX		
5243556	LF5243556	TECNOCONTROL	LEAK DETECTOR SE138PX ATEX	12÷24V	R290
5243557	LF5243557	TECNOCONTROL	CARTRIDGE FOR LEAK DETECTOR SE138PX		
5243558	LF5243558	TECNOCONTROL	MOUNTING BRACKET TR530 FOR SENSOR "SE"		
5243559	LF5243559	TECNOCONTROL	CASSETTA DI PROTEZIONE AR015		
5243560	LF5243560	TECNOCONTROL	PROTECTION BOX TR533		
5243561	LF5243561	TECNOCONTROL	CABLE GLAND ATEX ZT163		
5243562	LF5243562	TECNOCONTROL	CABLE GLAND ATEX ZT161		
5243563	LF5243563	TECNOCONTROL	AUDIBLE ALARM	230V	
5243564	LF5243564	TECNOCONTROL	WARING LIGHT	230V	

Liquid receives

LIQUID RECEIVERS



1



2



3

Photo	REPA IT Code	REPA DE Code	Volume	Dimensions	ODS connections
1	3370009	LF3370009	0.88 l	ø 77xh220 mm	6.2 mm
2	3370001	LF3370001	1.3 l	ø 100xh204 mm	6.2 mm
3	3370002	LF3370002	2.3 l	ø 120xh252 mm	8.2 mm

Gas taps and accessories

TAPS ROTALOCK



REPA IT Code	REPA DE Code	Swivel connection	SAE Flare connection
3370004	LF3370004	1" UNS	3/8"
3370005	LF3370005	1" UNS	1/2"

TAPS FOR TANKS



REPA IT Code	REPA DE Code	Model	Connection SAE	Connection NPT
3348914	LF3348914	6110/22	1/4"	1/4"

TAPS FOR HERMETIC UNITS



REPA IT Code	REPA DE Code	Model	Charging connection - Position SAE	Connection SAE	Connection ODF mm
3348911	LF3348911	6062/22M6	1/4" - side Rh	1/4"	6
3348912	LF3348912	6072/23M10	1/4" - side Lh	3/8"	10
3348913	LF3348913	6072/24M12	1/4" - side Lh	1/2"	12

Gas taps and accessories

CAP VALVES



REPA IT Code	REPA DE Code	Model	Threaded connection SAE	ODF connection mm - in.	Kv factor m ³ /h	Length mm
3348900	750551	6010/2	1/4" MM	-	0.27	58
3348901	750552	6410/2	1/4" MM	-	0.4	68
3348902	750553	6410/3	3/8" MM	-	1	74
3348903	750554	6410/4	1/2" MM	-	1.45	78
3348905	750555	6420/2	-	6 - 1/4"	0.4	57
3348906	750556	6420/M10	-	10	1	61
3348907	750557	6420/M12	-	12	1.45	70
3348908	LF3348908	6420/5	-	16 - 5/8"	1.7	71
3348909	LF3348909	6420/M18	-	18	3.5	92
3348910	LF3348910	6420/M22	-	22	3.5	94

BALL VALVES



REPA IT Code	REPA DE Code	Model	ODF connection mm - in.	Kv factor m ³ /h	Length mm
3348915	LF3348915	6570/M6	6	0.8	121
3348916	750535	6570/M10	10	3	121
3348917	750536	6570/M12	12	5	121
3348918	750537	6570/5	16 - 5/8"	17	139
3348919	LF3348919	6590/M18	18	17	139
3348920	LF3348920	6570/7	22 - 7/8"	29	175

CAPILLARIES



REPA IT Code	REPA DE Code	Length mm	Fittings	Depressor valve
3046011	LF3046011	500	1/4"sae	
3046013	696968	500	1/4"sae	x
3046001	694842	1000	1/4"sae	
3046014	694843	1000	1/4"sae	x
3046012	696777	1500	1/4"sae	
3046015	696778	1500	1/4"sae	x

CAPILLARIES CAP-KIT



REPA IT Code	REPA DE Code	Model	internal ø mm	Length mm
3046026	LF3046026	KK1H25	0,90	2000
3046025	LF3046025	KK2L25	1,06	3000
3046027	LF3046027	KK2H25	1,24	3000

Copper pipes

REFRIGERATION CAPILLARY TUBE



REPA IT Code	REPA DE Code	internal ø mm	Weight Kg	Length m
3449167	LF3449167	0.80		30
3046016	LF3046016	0.90	3	
35190263	35190263	1.06		40
3449168	LF3449168	1.10		30
3046051	23510236	1.25		30
35190265	35190265	1.37		40
3449169	LF3449169	1.60		30

ANNEALED COPPER PIPE IN ROLLS



REPA IT Code	REPA DE Code	external ø	Thickness mm	Weight g/m	Length m
3449600	LF3449600	6 mm	1	140	50
3449601	LF3449601	8 mm	1	197	50
3449602	LF3449602	10 mm	1	253	50
3449603	LF3449603	12 mm	1	309	50
3449604	LF3449604	14 mm	1	365	50
3449605	LF3449605	16 mm	1	421	50
3449191	LF3449191	1/4"	0.8	-	15
3449192	LF3449192	3/8"	0.8	-	15
3449193	LF3449193	1/2"	0.8	-	15

INSULATED COPPER PIPE



REPA IT Code	REPA DE Code	Pipe external ø	Pipe thickness mm	Insulation thickness mm	Length m
3449295	694749	1/4"	0.8	9	50
3449296	694750	3/8"	0.8	9	50
3449297	694751	1/2"	0.8	9	50
3449198	LF3449198	5/8"	1	9	25

DOUBLE TUBE INSULATED COPPER



REPA IT Code	REPA DE Code	Pipe external ø	Pipe thickness mm	Length m
41736243	41736243	1/4" - 3/8"	0.8 - 0.8	25
3046049	LF3046049	1/4" - 1/2"	0.8 - 0.8	20
3046050	LF3046050	3/8" - 5/8"	0.8 - 1	20

Vibration isolators for copper pipes

VIBRATION ISOLATORS FOR COPPER PIPE



REPA IT Code	REPA DE Code	Model	ODF connection mm	Length mm
3046002	LF3046002	VTG10	10	230
3046003	LF3046003	VTG12	12	230
3046004	LF3046004	VTG16	16	255
3046005	LF3046005	VTG18	18	255
3046006	LF3046006	VTG22	22	290
3046007	LF3046007	VTG28	28	330
3046008	LF3046008	VTG35	35	380
3046009	LF3046009	VTG42	42	435
3046010	LF3046010	VTG54	54	515

INSULATION PIPE 2 m ARMACELL



REPA IT Code	REPA DE Code	Model	Thickness	Internal diameter mm	Length m
3449172	LF3449172	XG 09X010	9	10	2
3449173	LF3449173	XG 09X012	9	12	2
3449174	LF3449174	XG 09X015	9	15	2
3449175	LF3449175	XG 09X018	9	18	2
3449176	LF3449176	XG 09X022	9	22	2
3449177	LF3449177	XG 13X010	13	10	2
3449178	694887	XG 13X012	13	12	2
3449180	LF3449180	XG 13X018	13	18	2
3449181	LF3449181	XG 13X022	13	22	2

XG - Temperature range -50°/+105°C

INSULATION PIPE IN ROLLS ARMACELL



REPA IT Code	REPA DE Code	Model	Thickness	Internal diameter mm	Length m
3180025	694746	XG 09X010/E	9	10	50
3180026	694747	XG 09X012/E	9	12	45
3180027	694748	XG 09X015/E	9	15	40
3180028	LF3180028	XG 09X018/E	9	18	38
3449186	LF3449186	XG 09X022/E	9	22	30
3180029	LF3180029	XG 13X010/E	13	10	35
3180030	LF3180030	XG 13X012/E	13	12	32
3180031	LF3180031	XG 13X015/E	13	15	28
3180032	LF3180032	XG 13X018/E	13	18	27
3449190	LF3449190	XG 13X022/E	13	22	26

XG - Temperature range -50°/+105°C

Mechanical microswitches

MICROSWITCHES CROUZET SERIES V3-83161 WITH ACTUATOR



REPA IT Code	REPA DE Code	Model	Contacts	Terminals	Max operating force	Features
3240568	345216	EF83161.3	1NO+1NC 16A 250V	6.3x0.8 mm	0.5N	with actuator 161E roller R=24.1 mm (pos.B)
5047787	LF5047787	EF83161.1	1NO+1NC 16A 250V	6.3x0.8 mm	1.5N	with actuator 161E roller R=24.1 mm (pos.B)

MICROSWITCHES CHERRY



Photo	REPA IT Code	REPA DE Code	Model	Contacts	Terminals	Colour	Suitable for
1	3803110	LF3803110	D3B	1NO+1NC 8A 250V	6.3x0.8 mm	white	ISA
2	3240355	347674	D42X	1NO+1NC 3A 250V	6.3x0.8 mm	white	STAFF ICE SYSTEM
3	3803137	LF3803137	D43X	1NO+1NC 6A 250V	6.3x0.8 mm	black	BREMA
4	5061167	LF5061167	E65	1NO+1NC 16A 250V	6.3x0.8 mm	white	FOSTER

MICROSWITCHES PIZZATO SERIES MK



REPA IT Code	REPA DE Code	Model	Contacts	Terminals
5061269	LF5061269	MKV11D10	1NO+1NC 16A 250V	screw
1240120	348145	MKV11D15	1NO+1NC 16A 250V	screw
5084071	LF5084071	MKV11D13	1NO+1NC 16A 250V	screw
9240007	LF9240007	MKV11D30	1NO+1NC 16A 250V	screw
3803104	LF3803104	MKV11D42	1NO+1NC 16A 250V	screw
3803136	LF3803136	MKV11D40	1NO+1NC 16A 250V	screw
3803105	LF3803105	VF MKCV12		protection terminal cover for multipolar cables from ø 4 to ø 7.5 mm

Mechanical microswitches

POSITION SWITCH PIZZATO SERIES FR



REPA IT Code	REPA DE Code	Model	Contacts
3803112	348261	FR502	1NO+1NC 3A 400V
3240155	345144	FR530-A	1NO+1NC 3A 400V

HVAC

HVAC



REPA IT Code	REPA DE Code	Description
3391099	LF3391099	"L" SUPPORTS 500x450mm
3391100	LF3391100	"L" SUPPORTS 550x450mm
3391101	LF3391101	"L" SUPPORTS 450x450mm
3445678	LF3445678	UNIVERSAL REMOTE CONTROLLER - AC
5103455	LF5103455	REFCO INVERTER CHECK TOOL
3122649	LF3122649	REFCO CONDENSATE DRAIN PUMP COMBI
3122938	LF3122938	REFCO CONDENSATE DRAIN PUMP GOBI II

DOUBLE TUBE INSULATED COPPER



REPA IT Code	REPA DE Code	Pipe external ø	Pipe thickness mm	Length m
41736243	41736243	1/4" - 3/8"	0.8 - 0.8	25
3046049	LF3046049	1/4" - 1/2"	0.8 - 0.8	20
3046050	LF3046050	3/8" - 5/8"	0.8 - 1	20

Cold room spare parts



REPA IT Code: 3242951
REPA DE Code: LF3242951

LATCH RH-LH WITHOUT LOCK 5240/3L

straight handle
length 205x28 mm
centre distance 104 mm



REPA IT Code: 3242952
REPA DE Code: LF3242952

LATCH RH-LH WITH LOCK 5240/3CL

straight handle
base length 205x28 mm
centre distance 104 mm



REPA IT Code: 3242953
REPA DE Code: LF3242953

LATCH RH-LH WITHOUT LOCK 5241L

curved handle
length 220x28 mm
centre distance 104 mm



REPA IT Code: 3242950
REPA DE Code: 694080

LATCH RH-LH WITHOUT LOCK 5244L

dimension 248x28 mm
centre distance 112 mm
nylon catch



REPA IT Code: 3242921
REPA DE Code: LF3242921

LATCH RH-LH WITHOUT LOCK 560 CR

straight handle
base length 150x23x30h mm
centre distance 110 mm



REPA IT Code: 3242579
REPA DE Code: 690455

LATCH RH-LH WITHOUT LOCK 570 CR

straight handle
base length 150x23x30h mm
centre distance 110 mm
coupling height 16.5 mm



REPA IT Code: 3242945
REPA DE Code: 690456

LATCH RH-LH WITH LOCK 571 CR

straight handle
base length 150x23x30h mm
centre distance 110 mm
coupling height 16.5 mm



REPA IT Code: 3242922
REPA DE Code: 690428

LOCKING LATCH

coupling height 16.5 mm



REPA IT Code: 3242581
REPA DE Code: 690416

LATCH RH-LH WITHOUT LOCK 880 PV

black plastic straight handle
base length 122x28x35h mm
centre distance 104 mm
adjustable coupling centre distance 31 mm



REPA IT Code: 3242386
REPA DE Code: 700557

LATCH RH-LH WITHOUT LOCK 880 CR

straight handle
base length 120x28x39h mm
centre distance 104 mm
adjustable coupling centre distance 31 mm



REPA IT Code: 3242582
REPA DE Code: 690417

LATCH RH-LH WITH LOCK 885 PV

black plastic straight handle
base length 122x28x35h mm
centre distance 104 mm
adjustable coupling centre distance 31 mm



REPA IT Code: 3242583
REPA DE Code: 700556

LATCH RH-LH WITH LOCK 885 CR

straight handle
base length 122x28x35h mm
centre distance 104 mm
adjustable coupling centre distance 31 mm

Cold room spare parts



REPA IT Code: 3242584
REPA DE Code: LF3242584

LATCH RH-LH WITH LOCK 885 CR HP

straight handle
base length 122x28x35h mm
centre distance 104 mm
adjustable coupling centre distance 31 mm



REPA IT Code: 3242946
REPA DE Code: 690412

LATCH RH-LH WITHOUT LOCK 790 CR

straight handle
length 254x30 mm
centre distance 133 mm
adjustable coupling from 9 to 22 mm



REPA IT Code: 3242948
REPA DE Code: 690413

LATCH RH-LH WITH LOCK 795 CR

straight handle
base length 150x30x40.5h mm
centre distance 133 mm
adjustable coupling from 9 to 22 mm



REPA IT Code: 3242947
REPA DE Code: 690414

LATCH RH-LH WITHOUT LOCK 791 CR

curved handle
length 254x30 mm - centre distance 133 mm
adjustable coupling from 9 to 22 mm



REPA IT Code: 3242949
REPA DE Code: 690415

LATCH RH-LH WITH LOCK 796 CR

curved handle
base length 150x30x40.5h mm
centre distance 133 mm
adjustable coupling from 9 to 22 mm



REPA IT Code: 3242042
REPA DE Code: LF3242042

COUPLING FOR HANDLE CHROME-PLATED

58x35x18 mm
hole spacing 42 ± 2.5 mm



REPA IT Code: 3242178
REPA DE Code: 692963

LATCH RH-LH WITHOUT LOCK

straight handle
base length 135x27 mm
centre distance 120 mm
adjustable coupling



REPA IT Code: 3242179
REPA DE Code: 690402

LATCH RH-LH WITHOUT LOCK

curved handle
base length 135x27 mm
centre distance 120 mm
adjustable coupling



REPA IT Code: 3242180
REPA DE Code: 690401

LATCH RH-LH WITH LOCK

straight handle
base length 135x27 mm
centre distance 120 mm
adjustable coupling



REPA IT Code: 3242184
REPA DE Code: 690403

LATCH RH-LH WITH LOCK

curved handle
base length 135x27 mm
centre distance 120 mm
adjustable coupling



REPA IT Code: 3242185
REPA DE Code: 690404

LATCH RH-LH WITHOUT LOCK

straight handle
base length 147x32 mm
centre distance 118-134 mm
adjustable coupling



REPA IT Code: 3242187
REPA DE Code: 701679

LATCH RH-LH WITH LOCK

straight handle
base length 147x32 mm
centre distance 118-134 mm
adjustable coupling

Cold room spare parts



REPA IT Code: 3242403
REPA DE Code: LF3242403

LATCH RH-LH WITHOUT LOCK L520

length 215x28 mm
centre distance 120 mm



REPA IT Code: 3242510
REPA DE Code: LF3242510

LATCH RH-LH WITHOUT LOCK 533D

straight handle
base length 133x25xh48 mm
centre distance 95.3-114.4 mm
adjustable coupling centre distance 40 mm



REPA IT Code: 3242401
REPA DE Code: LF3242401

LATCH RH-LH WITHOUT LOCK 174 CR

curved handle
length 267x25 mm
centre distance 118-134 mm
adjustable hook



REPA IT Code: 3242384
REPA DE Code: LF3242384

LATCH RH-LH WITH LOCK 174 CR

curved handle
length 267x25 mm
distance between holes 118-134 mm
adjustable coupling



REPA IT Code: 3242157
REPA DE Code: 694001

LATCH RH-LH WITHOUT LOCK

chrome-plated metal
base length 185x24x33h mm
centre distance 150 mm
adjustable coupling centre distance 26 mm



REPA IT Code: 3242158
REPA DE Code: LF3242158

LATCH RH-LH WITHOUT LOCK

base length 185x24x33h mm
centre distance 150 mm
adjustable coupling centre distance 26 mm



REPA IT Code: 3242172
REPA DE Code: LF3242172

LATCH RH-LH WITHOUT LOCK

grey metal
base length 185x24x33h mm
hole spacing 150 mm
adjustable coupling centre distance 26 mm



REPA IT Code: 3242155
REPA DE Code: 694002

LATCH RH-LH WITH LOCK

chrome-plated metal
base length 185x24x33h mm
centre distance 150 mm
adjustable coupling centre distance 26 mm



REPA IT Code: 3242156
REPA DE Code: LF3242156

LATCH RH-LH WITH LOCK

black metal
base length 185x24x33h mm
centre distance 150 mm
adjustable coupling centre distance 26 mm



REPA IT Code: 3242171
REPA DE Code: 10569517

LATCH RH-LH WITH LOCK

grey metal
base length 185x24x33h mm
centre distance 150 mm
adjustable coupling centre distance 26 mm



REPA IT Code: 3242220
REPA DE Code: 700081

LATCH ERGO 6188 WITHOUT LOCK CHROME-PLATED

RAHRBACH - centre distance 150 mm
base length 185.5x23.5x33.2h mm



REPA IT Code: 3242307
REPA DE Code: 690016

LATCH ERGO 6188 WITH LOCK CHROME-PLATED

straight handle
base length 185.5x23.5x33.2h mm
centre distance 150 mm
RAHRBACH

Cold room spare parts



REPA IT Code: 3242221
REPA DE Code: 700082

ADJUSTABLE COUPLING CHROME-PLATED

base length 38x18x31 mm
fixing centre distance 26 mm
RAHRBACH



REPA IT Code: 3242306
REPA DE Code: 690947

SHIM 5 mm

RAHRBACH



REPA IT Code: 3242188
REPA DE Code: LF3242188

LATCH RH-LH WITHOUT LOCK

straight handle
base length 138x28x32h mm
centre distance 118 mm
adjustable coupling centre distance 30 mm



REPA IT Code: 3242194
REPA DE Code: 10569513

LATCH RH-LH WITH LOCK

straight handle
base length 138x28 mm
centre distance 118 mm
adjustable coupling



REPA IT Code: 3242329
REPA DE Code: 701675

LATCH RH-LH WITHOUT LOCK

centre distance 118 mm
dimensions 137x28x31.5 mm
STUV



REPA IT Code: 3242325
REPA DE Code: 701674

LATCH RH-LH WITH LOCK

centre distance 118 mm
dimensions 137x28x31.5 mm
STUV



REPA IT Code: 3242330
REPA DE Code: 700078

COUPLING 15°

STUV



REPA IT Code: 3242169
REPA DE Code: LF3242169

LATCH RH-LH WITHOUT LOCK

chrome plated metal
base length 185x24x76h mm
centre distance 150 mm
adjustable coupling centre distance 26 mm



REPA IT Code: 3242170
REPA DE Code: 690396

LATCH RH-LH WITH LOCK

chrome plated metal
base length 185x24x76h mm
centre distance 150 mm
adjustable coupling centre distance 26 mm



REPA IT Code: 3242406
REPA DE Code: LF3242406

LATCH RH-LH WITHOUT LOCK

base length 185x24x76h mm
centre distance 150 mm
adjustable coupling centre distance 26 mm



REPA IT Code: 3242405
REPA DE Code: LF3242405

LATCH RH-LH WITH LOCK

base length 185x24x76h mm
centre distance 150 mm
adjustable coupling centre distance 26 mm



REPA IT Code: 3242308
REPA DE Code: 690019

LATCH ERGO 6190 WITHOUT LOCK CHROME-PLATED

base length 185.5x23.5x75h mm
centre distance 150 mm
RAHRBACH

Cold room spare parts



REPA IT Code: 3242309
REPA DE Code: 690020

LATCH ERGO 6190 C/ SERRATURA CHROME- PLATED

base length 185.5x23.5x75h mm
centre distance 150 mm
RAHRBACH



REPA IT Code: 3242256
REPA DE Code: LF3242256

LATCH RH-LH WITHOUT LOCK

base length 138x28x80h mm
centre distance 118 mm
adjustable coupling centre
distance 26 mm



REPA IT Code: 3242244
REPA DE Code: LF3242244

LATCH RH-LH WITH LOCK

base length 138x28x80h mm
centre distance 118 mm
adjustable coupling centre
distance 26 mm



REPA IT Code: 3242332
REPA DE Code: 690223

LATCH RH-LH WITHOUT LOCK

centre distance 118 mm
dimensions 137x28x81 mm
STUV



REPA IT Code: 3242333
REPA DE Code: 690222

LATCH RH-LH WITH LOCK

centre distance 118 mm
dimensions 137x28x81 mm
STUV



REPA IT Code: 3242334
REPA DE Code: 701540

COUPLING 33°

STUV



REPA IT Code: 3242239
REPA DE Code: 694007

LATCH RH-LH WITHOUT LOCK

base length 138x28x80h mm
centre distance 118 mm
adjustable coupling centre
distance 26 mm



REPA IT Code: 3242199
REPA DE Code: LF3242199

LATCH RH-LH WITH LOCK

base length 138x28x80h mm
centre distance 118 mm
adjustable coupling centre
distance 26 mm



REPA IT Code: 3242339
REPA DE Code: 700039

LATCH RH-LH WITHOUT LOCK

centre distance 118 mm
dimensions 190x28x81 mm
STUV



REPA IT Code: 3242335
REPA DE Code: 700038

LATCH RH-LH WITH LOCK

centre distance 118 mm
dimensions 190x28x81 mm
STUV



REPA IT Code: 3242350
REPA DE Code: 701541

COUPLING 22°



REPA IT Code: 3242259
REPA DE Code: 690008

HANDGRIP PROFILE 600 mm

Cold room spare parts



REPA IT Code: 3242263
REPA DE Code: LF3242263

DOOR HANDLE CHROME-PLATED

complete with coupling
handle centre distance 36-41 mm



REPA IT Code: 3242264
REPA DE Code: LF3242264

DOOR HANDLE CHROME-PLATED

complete w/lock - centre distance 46-15 mm
handle centre distance 41x45x46 mm



REPA IT Code: 3242369
REPA DE Code: 700558

HANDLE 651

complete with fastening - distance 44-16.5 mm
handle centre distance 35-44-45.5 mm



REPA IT Code: 3242370
REPA DE Code: 700590

HANDLE 652

with coupling - centre distance 42-14.5 mm
handle centre distance 31-35-36 mm



REPA IT Code: 3242585
REPA DE Code: 700589

LATCHING HOOK

hole spacing 35 mm
adjustable from 18 to 30 mm



REPA IT Code: 3242595
REPA DE Code: 700587

LATCHING HOOK

hole spacing 43 mm
adjustable from 14 to 30 mm



REPA IT Code: 3242393
REPA DE Code: LF3242393

LATCH 930 WITH HOOK

length 150xh52 mm
handle centre distance 38-34-21 mm
coupling centre distance 38-12 mm



REPA IT Code: 3242402
REPA DE Code: LF3242402

LATCH 931 WITH HOOK

length 150xh60 mm
centre distance for handle 44-41-25 mm
coupling centre distance 38-22 mm



REPA IT Code: 3242268
REPA DE Code: LF3242268

LATCH COMPLETE WITH LOCK 265 mm

complete with internal button
coupling centre distance 55-30 mm
outside handle centre distance 52-78 mm



REPA IT Code: 3242388
REPA DE Code: LF3242388

LATCH WITH LOCK 56

length 280 mm
centre distance 86-54-63.5 mm



REPA IT Code: 3242389
REPA DE Code: LF3242389

LATCHING HOOK 56

adjustable height from 23 to 44 mm
centre distance 58-65-23 mm



REPA IT Code: 3242390
REPA DE Code: LF3242390

LATCHING HOOK 56

adjustable height from 48 to 70 mm
centre distance 58-65-23 mm

Cold room spare parts



REPA IT Code: 3242391
REPA DE Code: LF3242391

LATCH WITH LOCK 58

length 262 mm
centre distance 78-52.4 mm



REPA IT Code: 3242392
REPA DE Code: LF3242392

LATCHING HOOK 58

adjustable height from 26 to 40 mm
centre distance 56-29 mm



REPA IT Code: 3242400
REPA DE Code: LF3242400

LATCHING HOOK 58

adjustable height from 40 to 60 mm
centre distance 56-29 mm



REPA IT Code: 3242387
REPA DE Code: LF3242387

INTERNAL OPENING PUSH BUTTON 481

for handle 56-58



REPA IT Code: 3242394
REPA DE Code: LF3242394

LATCH 55 WITHOUT LOCK

complete with inside handle and coupling - length 245 mm
handle centre distance 74-80-86 mm
catch centre distance 32-86 mm
internal handle centre distance 51-65 mm



REPA IT Code: 3242385
REPA DE Code: 512528

HYDRAULIC LOCK 1092

length 35x35xh111 mm
coupling centre distance 15-20 mm



REPA IT Code: 3242960
REPA DE Code: 690457

CELL HANDLE RH-LH 1825

centre distance 158 mm
plate dimensions 181x33 mm



REPA IT Code: 3242959
REPA DE Code: 690678

ADDITIONAL LOCK 1875

centre distance 158 mm
dimensions 181x33 mm



REPA IT Code: 3242981
REPA DE Code: 700786

CELL HANDLE RH-LH WITHOUT LOCK 2025

dimensions 197x44x59 mm



REPA IT Code: 3242983
REPA DE Code: 694091

ADJUSTABLE COUPLING



REPA IT Code: 3242982
REPA DE Code: 700787

ADDITIONAL LOCK 075

122x44x59 mm



REPA IT Code: 3242281
REPA DE Code: 700825

INTERNAL SAFETY HANDLE 2700

length 300 mm
centre distance 65x35 mm

Cold room spare parts



REPA IT Code: 3242530
REPA DE Code: 694079

LATCH 2225 RH-LH WITH LOCK

with internal handle
with lock release device



REPA IT Code: 3242731
REPA DE Code: 700393

CELL HANDLE RH-LH WITHOUT LOCK 3025

dimensions 200x39x59 mm



REPA IT Code: 3242549
REPA DE Code: LF3242549

LATCH 1926 RH 3-POINT WITH KEY

including:
1 external handle
2 blocks
2 block hooks
1 internal latch button



REPA IT Code: 3242557
REPA DE Code: 700572

COUPLING



REPA IT Code: 3242551
REPA DE Code: 700571

ADDITIONAL LOCK

centre distance 121-136 mm



REPA IT Code: 3242356
REPA DE Code: 700611

LATCH 1220 LH 3-POINT

1 external handle
2 locks and 2 lock clamps



REPA IT Code: 3242355
REPA DE Code: 700612

LATCH 1220 RH 3-POINT

consisting of 1 external handle
2 blocks and 2 block hooks



REPA IT Code: 3242553
REPA DE Code: 700614

LATCH 1221 RH 3-POINT WITH KEY

including:
1 external handle
2 blocks
2 block hooks
1 internal latch button



REPA IT Code: 3242554
REPA DE Code: 700609

ADDITIONAL LOCK 90x52 mm



REPA IT Code: 3242562
REPA DE Code: 700610

COUPLING FOR ADDITIONAL LATCH



REPA IT Code: 3242968
REPA DE Code: 694777

CELL DOOR HANDLE RH 300 mm

for panel thicknesses over 100 mm
fixing plate 150x48x120 mm



REPA IT Code: 3242964
REPA DE Code: 694778

CELL DOOR HANDLE LH 300 mm

for panel thicknesses over 100 mm
fixing plate 150x48x120 mm

Cold room spare parts



REPA IT Code: 3242965
REPA DE Code: LF3242965

ADDITIONAL LOCK CHROME-PLATED

100x55xh60 mm



REPA IT Code: 3242963
REPA DE Code: LF3242963

STRIKE PLATE

dimension 99x47x7 mm



REPA IT Code: 3242966
REPA DE Code: 696890

CELL DOOR HANDLE RH 420 mm

for panel thicknesses over 100 mm
fixing plate 160x70x120 mm



REPA IT Code: 3242961
REPA DE Code: 696891

CELL DOOR HANDLE LH 420 mm

for panel thicknesses over 100 mm
fixing plate 160x70x120 mm



REPA IT Code: 3242962
REPA DE Code: LF3242962

ADDITIONAL LOCK CHROME-PLATED

110x70xh72 mm



REPA IT Code: 3242975
REPA DE Code: LF3242975

STRIKE PLATE

dimension 109x56x7 mm



REPA IT Code: 3242967
REPA DE Code: S0201738

ANTI-PANIC SAFETY HANDLE 300 m

centre distance 41x65 mm



REPA IT Code: 3242970
REPA DE Code: LF3242970

ANTI-PANIC HANDLE STRIKER



REPA IT Code: 3242720
REPA DE Code: LF3242720

LATCH 4225 RH

complete with internal handle
with lock release device



REPA IT Code: 3242721
REPA DE Code: LF3242721

DOOR SHIM KIT 60/80 mm



REPA IT Code: 3242722
REPA DE Code: LF3242722

DOOR SHIM KIT 81/100 mm



REPA IT Code: 3242723
REPA DE Code: LF3242723

DOOR SHIM KIT 101/120 mm



REPA IT Code: 3242536
REPA DE Code: 694081

LATCH 5325AB WITH LOCK

dimensions 195.5x147.3xh39 mm



REPA IT Code: 3242537
REPA DE Code: 694082

DOOR SHIM KIT 50/60 mm



REPA IT Code: 3242538
REPA DE Code: 694083

DOOR SHIM KIT 61/80 mm



REPA IT Code: 3242539
REPA DE Code: 694084

DOOR SHIM KIT 81/100 mm

Cold room spare parts



REPA IT Code: 3242740
REPA DE Code: LF3242740

LATCH 7325CQN WITH LOCK

with internal safety push-button
complete with strike hook 27/42 mm



REPA IT Code: 3242760
REPA DE Code: 694894

KIT 7000 DOOR THICKNESS 50/69 mm



REPA IT Code: 3242761
REPA DE Code: LF3242761

KIT 7000 DOOR THICKNESS 70/89 mm



REPA IT Code: 3242762
REPA DE Code: 694895

KIT 7000 DOOR THICKNESS 90/109 mm



REPA IT Code: 3242763
REPA DE Code: 694896

KIT 7000 DOOR THICKNESS 110/129 mm



REPA IT Code: 3242741
REPA DE Code: 694898

STRIKE SHIM 42/57 mm



REPA IT Code: 3242742
REPA DE Code: 694899

STRIKE SHIM 57/72 mm



REPA IT Code: 3242743
REPA DE Code: LF3242743

STRIKE SHIM 72/87 mm



REPA IT Code: 3242744
REPA DE Code: 694900

STRIKE SHIM 87/102 mm



REPA IT Code: 3242294
REPA DE Code: LF3242294

LATCH 5660 WITHOUT LOCK

for door thickness 80/90 mm



REPA IT Code: 3242295
REPA DE Code: LF3242295

LATCH 5660 WITH LOCK

for door thickness 80/90 mm



REPA IT Code: 3242296
REPA DE Code: LF3242296

LATCH 5660 WITHOUT LOCK

for door thickness 60/70 mm



REPA IT Code: 3242297
REPA DE Code: LF3242297

LATCH 5660 WITH LOCK

for door thickness 60/70 mm



REPA IT Code: 3242541
REPA DE Code: LF3242541

BALL LATCH WITH LOCK

with internal safety handle
door thickness 50 to 140 mm
rh/lh reversible



REPA IT Code: 3242542
REPA DE Code: 690993

LATCH ACTIVA WITH LOCK

with internal safety handle
door thickness 50 to 140 mm
rh/lh reversible



REPA IT Code: 7105217
REPA DE Code: S0085743

LATCH 4181 WITH LOCK

with internal safety handle

Cold room spare parts



REPA IT Code: 3242751
REPA DE Code: 701502

LATCH 431 WITH LOCK

with internal safety handle
door thickness from 67 to 115 mm



REPA IT Code: 3242752
REPA DE Code: 700616

LATCH 431 WITH LOCK

with internal safety handle
door thickness from 116 to 165 mm



REPA IT Code: 3242572
REPA DE Code: LF3242572

LATCH WITHOUT HOOK 521 HP

with lock
238x136.5 mm



REPA IT Code: 3242573
REPA DE Code: LF3242573

COUPLING HP FOR DOOR THICKNESS 27/43 mm



REPA IT Code: 3242574
REPA DE Code: LF3242574

COUPLING HP FOR DOOR THICKNESS 44/60 mm



REPA IT Code: 3242575
REPA DE Code: LF3242575

COUPLING HP FOR DOOR THICKNESS 61/77 mm



REPA IT Code: 3242576
REPA DE Code: LF3242576

COUPLING HP FOR DOOR THICKNESS 78/94 mm



REPA IT Code: 3242577
REPA DE Code: LF3242577

COUPLING HP FOR DOOR THICKNESS 95/111 mm



REPA IT Code: 3242563
REPA DE Code: 692532

LOCK BLOCK

for 921HP



REPA IT Code: 3242348
REPA DE Code: 700576

LATCH 620

without key lock
213x104xh50 mm



REPA IT Code: 3242349
REPA DE Code: 700784

LATCH 621 WITH LOCK

213x104xh50 mm



REPA IT Code: 3242560
REPA DE Code: 700619

LATCHING HOOK 620/621



REPA IT Code: 3242396
REPA DE Code: 700795

SHIM 15 mm

for door thickness 42/57 mm



REPA IT Code: 3242397
REPA DE Code: 700796

SHIM 30 mm

for door thickness 57/72 mm



REPA IT Code: 3242398
REPA DE Code: LF3242398

SHIM 40 mm

for door thickness 67/80 mm



REPA IT Code: 3242357
REPA DE Code: LF3242357

LATCH WITHOUT HOOK 920

without key lock
245x108xh52 mm

Cold room spare parts



REPA IT Code: 3242358
REPA DE Code: 701645

LATCH WITHOUT HOOK 921

with key lock
245x108xh52 mm



REPA IT Code: 3242395
REPA DE Code: 700577

DOOR SHIM FITTING 27/42 mm



REPA IT Code: 3242399
REPA DE Code: 700578

DOOR SHIM FITTING 42/57 mm



REPA IT Code: 3242359
REPA DE Code: 700579

DOOR SHIM FITTING 52/72 mm

for lock 920/921



REPA IT Code: 3242360
REPA DE Code: 700580

DOOR SHIM FITTING 69/89 mm

for lock 920/921



REPA IT Code: 3242545
REPA DE Code: 700574

LATCH WITHOUT HOOK 921HP



REPA IT Code: 3242546
REPA DE Code: 700797

SEAL FOR LOCK 50 mm



REPA IT Code: 3242568
REPA DE Code: LF3242568

COUPLING HP FOR DOOR THICKNESS 27/42 mm

for 921HP



REPA IT Code: 3242548
REPA DE Code:

COUPLING HP FOR DOOR THICKNESS 42/57 mm

for 921HP



REPA IT Code: 3242708
REPA DE Code:

COUPLING HP FOR DOOR THICKNESS 52/72 mm

for 921 HP



REPA IT Code: 3242561
REPA DE Code: LF3242561

COUPLING HP FOR DOOR THICKNESS 52/72 mm

for 921HP
with microswitch inserted in the coupling
allows the controls of:
- door open/door closed indicator
- calculation of opening/closing operations
- alarm disengagement
- stop of evaporators and fans
Operating voltages 12 V (10 A) - 24 V (5A)
with cable 1500 mm



REPA IT Code: 3242569
REPA DE Code: 701043

COUPLING HP FOR DOOR THICKNESS 69/89 mm

for 921HP

Cold room spare parts



REPA IT Code: 3242570
REPA DE Code: 700791

COUPLING HP FOR DOOR THICKNESS 86/106 mm

for 921HP



REPA IT Code: 3242361
REPA DE Code: 700618

INTERNAL RELEASE PUSH-BUTTON

for lock 620/621/920/921



REPA IT Code: 3242362
REPA DE Code: 701418

CAP GREEN



REPA IT Code: 3242702
REPA DE Code: 694074

EXTERNAL HANDLE 500TN

without lock
200x110xh50 mm



REPA IT Code: 3242700
REPA DE Code: 694077

EXTERNAL HANDLE WITH LOCK 500TN

200x110xh50 mm



REPA IT Code: 3242701
REPA DE Code: LF3242701

INTERNAL HANDLE CSI 500TN

79x145 mm
fixing centre distance 110 mm



REPA IT Code: 3250226
REPA DE Code: 694523

SPRING FOR INTERNAL CATCH

for handles from 2013 onwards
for old model the handle
requires replacing
LF code 3242701



REPA IT Code: 3242996
REPA DE Code: 694078

HANDLE KIT COMPLETE 265 mm

with mushroom-shaped pin for
opening from inside
for COLD ROOM doors doors w/
thickness 60÷70 mm



REPA IT Code: 3242917
REPA DE Code: 694087

HANDLE KIT COMPLETE

with mushroom-shaped pin for
opening from inside
for COLD ROOM doors doors w/
thickness 80÷90 mm



REPA IT Code: 3242918
REPA DE Code: 694088

HANDLE KIT COMPLETE

with mushroom-shaped pin for
opening from inside
for COLD ROOM doors doors w/
thicknes 100÷110 mm



REPA IT Code: 3242890
REPA DE Code: 692917

HANDLE JUMBO WITH KEY

length 300 mm



REPA IT Code: 3242095
REPA DE Code: 692885

UPPER PART LATCH

61x60xh48 mm



REPA IT Code: 3242096
REPA DE Code: 690061

DOOR STRIKE PLATE 30-43 mm



REPA IT Code: 3242097
REPA DE Code:

DOOR STRIKE PLATE 51-65 mm



REPA IT Code: 3242540
REPA DE Code:

DOOR STRIKE PLATE 71-85 mm



REPA IT Code: 3242894
REPA DE Code: 690069

INTERNAL BUTTON 108-124 mm

Cold room spare parts



REPA IT Code: 3242891
REPA DE Code: 690066

INTERNAL BUTTON 60-76 mm



REPA IT Code: 3242892
REPA DE Code:

INTERNAL BUTTON 76-92 mm



REPA IT Code: 3242893
REPA DE Code: 690068

INTERNAL BUTTON 92-108 mm



REPA IT Code: 3242439
REPA DE Code: 692761

STRIKE ROLL JUMBO



REPA IT Code: 3242098
REPA DE Code: 690064

SHIM 7.5 mm



REPA IT Code: 3242313
REPA DE Code: 690002

DOOR LATCH RH THICKNESS 80 mm

STUV



REPA IT Code: 3242314
REPA DE Code: 691948

DOOR LATCH RH THICKNESS 90 mm

STUV



REPA IT Code: 3242315
REPA DE Code: 690326

DOOR LATCH RH THICKNESS 100 mm

STUV



REPA IT Code: 3242321
REPA DE Code: 690160

DOOR LATCH RH THICKNESS 120 mm

STUV



REPA IT Code: 3242323
REPA DE Code: 690164

SHIM 11 mm

STUV



REPA IT Code: 3242324
REPA DE Code: 690165

SHIM 18 mm

STUV



REPA IT Code: 3242322
REPA DE Code: 692961

INTERNAL HANDLE STRIKER

STUV



REPA IT Code: 3242703
REPA DE Code: 694779

EXTERNAL HANDLE 480TN COMPLETE

handle length 551 mm
for doors model 480TN-480LWT-480GV-480BIN.INT.



REPA IT Code: 3242704
REPA DE Code: 694245

INTERNAL HANDLE 480TN NEW TYPE RH

length 765 mm
mounting bracket 165x60 mm
for COLD ROOMS model 480TN-480LWT-480GV-480BIN.INT

GASKETS

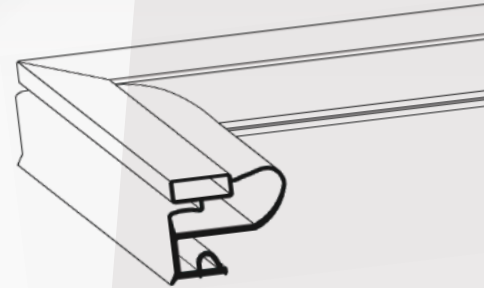

Gaskets are crucial in maintaining the efficiency of your equipment. Over time, wear and stress can compromise their sealing ability, leading to leaks or inefficiencies. Timely maintenance helps prevent costly breakdowns, extends the lifespan of your equipment and ensures optimal performance.

REPA provides a wide range of over 100 gasket profiles **always in stock**, some of the fastest shipping times on the market and high-quality products at competitive prices. If you need **custom-sized seals**, you can order the perfect gasket for your needs thanks to our intuitive online configurator.

More value
for you

1 A wide portfolio covering **more than 100 gasket profiles**.

2 High-precision manufacturing and **superior material quality** for long-lasting sealing performance.

3 **Online configurator** available to create your perfect gasket.

4 Custom-made gaskets delivered in **just a few days**.

Snap-in gasket profiles

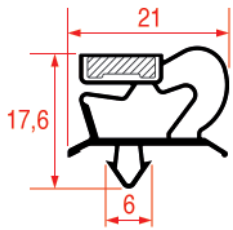

REPA IT PROFILE CODE - 1001
REPA DE PROFILE CODE - 9048

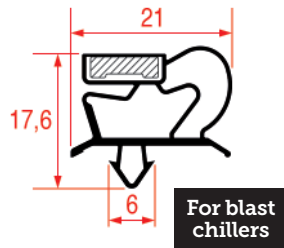

REPA IT PROFILE CODE - 3001
REPA DE PROFILE CODE - 8048

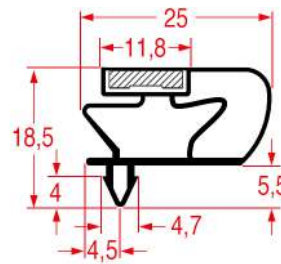

REPA DE PROFILE CODE - 9799

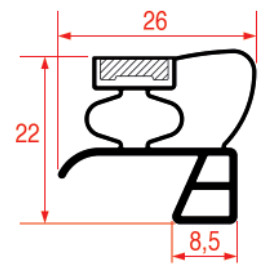

REPA IT PROFILE CODE - 1002
REPA DE PROFILE CODE - 9783

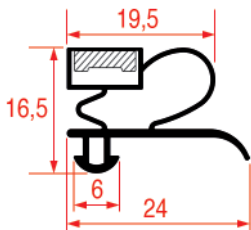

REPA IT PROFILE CODE - 1003
REPA DE PROFILE CODE - 9333

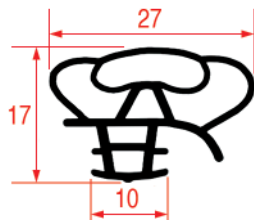

REPA IT PROFILE CODE - 1004

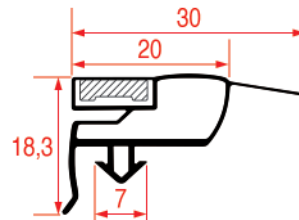

REPA IT PROFILE CODE - 1005
REPA DE PROFILE CODE - 9773

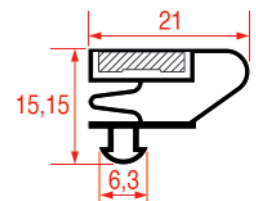

REPA IT PROFILE CODE - 1006
REPA DE PROFILE CODE - 9703

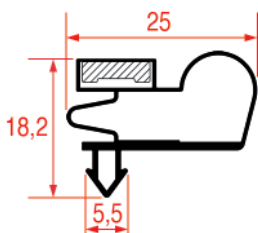

REPA IT PROFILE CODE - 1007
REPA DE PROFILE CODE - 9010

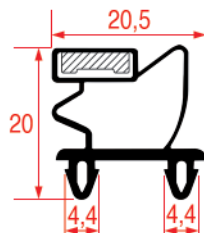

REPA IT PROFILE CODE - 1008
REPA DE PROFILE CODE - 9795

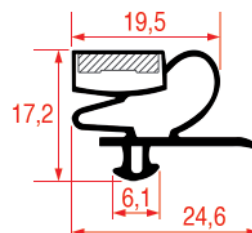

REPA IT PROFILE CODE - 1009
REPA DE PROFILE CODE - 9012

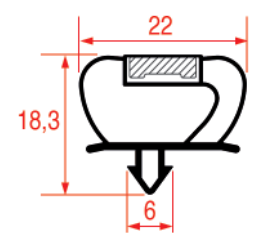

REPA IT PROFILE CODE - 1010
REPA DE PROFILE CODE - 9237

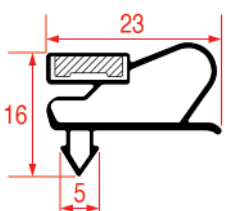

REPA IT PROFILE CODE - 1011
REPA DE PROFILE CODE - 9050

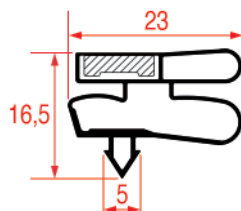

REPA IT PROFILE CODE - 1012
REPA DE PROFILE CODE - 9151

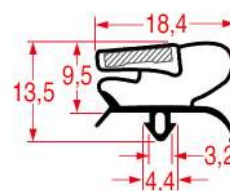

REPA DE PROFILE CODE - 9056

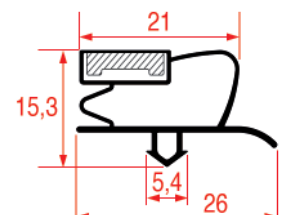

REPA IT PROFILE CODE - 1013
REPA DE PROFILE CODE - 9013

Snap-in gasket profiles

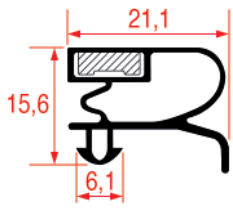

REPA IT PROFILE CODE - 1014
REPA DE PROFILE CODE - 9753

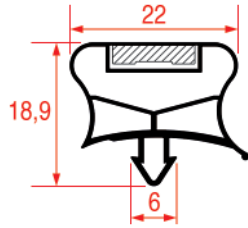

REPA IT PROFILE CODE - 1016
REPA DE PROFILE CODE - 9794

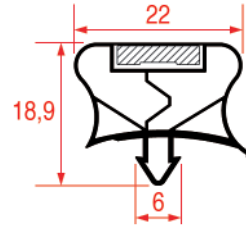

REPA IT PROFILE CODE - 1116
REPA DE PROFILE CODE - 9792

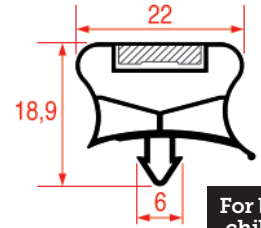

REPA IT PROFILE CODE - 3016
REPA DE PROFILE CODE - 8794

For blast chillers

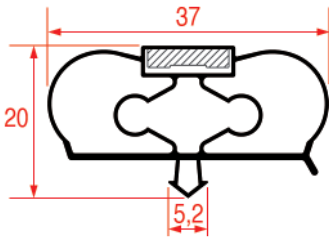

REPA IT PROFILE CODE - 1017
REPA DE PROFILE CODE - 9798

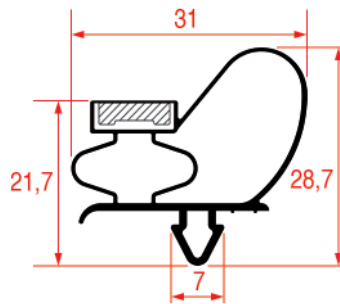

REPA IT PROFILE CODE - 1018
REPA DE PROFILE CODE - 9743

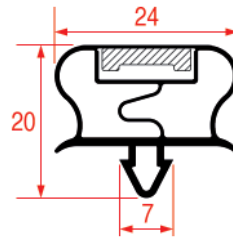

REPA IT PROFILE CODE - 1019
REPA DE PROFILE CODE - 8195

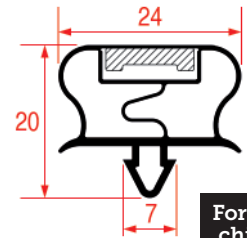

REPA IT PROFILE CODE - 8195
REPA DE PROFILE CODE - 8195

For blast chillers

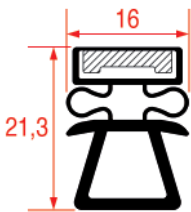

REPA IT PROFILE CODE - 1020
REPA DE PROFILE CODE - 9162

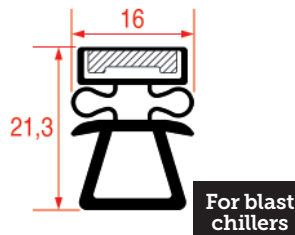

REPA IT PROFILE CODE - 8162
REPA DE PROFILE CODE - 8162

For blast chillers

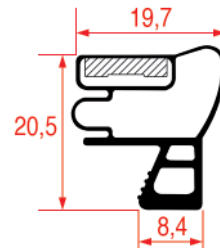

REPA IT PROFILE CODE - 1021
REPA DE PROFILE CODE - 9036

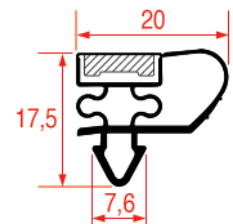

REPA IT PROFILE CODE - 1022
REPA DE PROFILE CODE - 9153

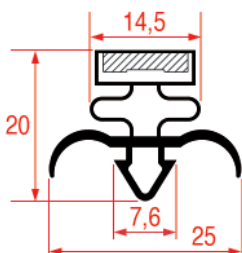

REPA IT PROFILE CODE - 1023
REPA DE PROFILE CODE - 9171

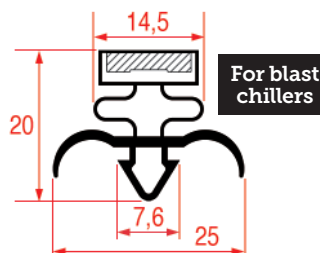

REPA IT PROFILE CODE - 8171
REPA DE PROFILE CODE - 8171

For blast chillers

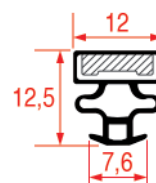

REPA IT PROFILE CODE - 1024
REPA DE PROFILE CODE - 9373

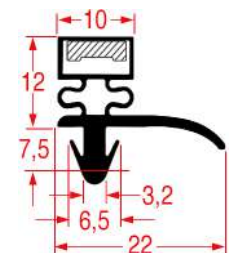

REPA DE PROFILE CODE - 9040

Snap-in gasket profiles

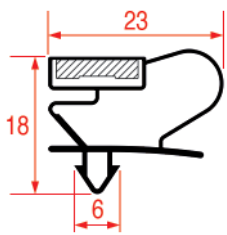

REPA IT PROFILE CODE - 1025
REPA DE PROFILE CODE - 9046

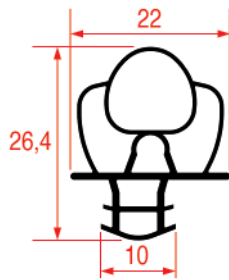

REPA IT PROFILE CODE - 1026
REPA DE PROFILE CODE - 9650

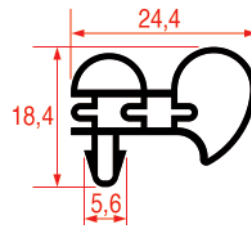

REPA IT PROFILE CODE - 1027
REPA DE PROFILE CODE - 9431

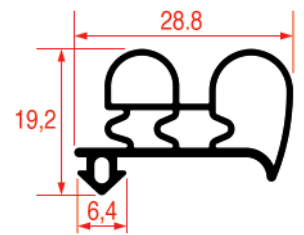

REPA IT PROFILE CODE - 1028
REPA DE PROFILE CODE - 9430

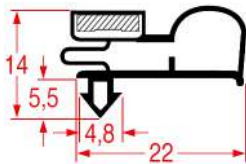

REPA DE PROFILE CODE - 9763

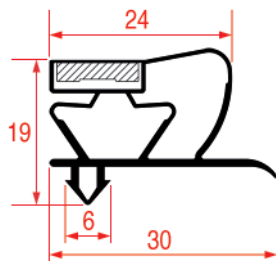

REPA IT PROFILE CODE - 1029
REPA DE PROFILE CODE - 9045

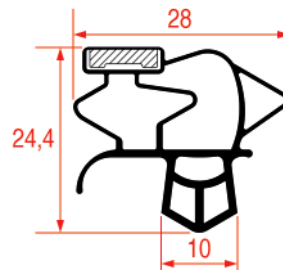

REPA IT PROFILE CODE - 1030
REPA DE PROFILE CODE - 9793

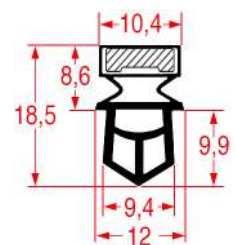

REPA DE PROFILE CODE - 9325

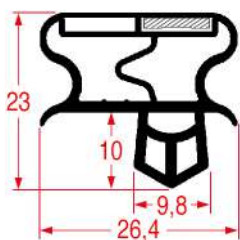

REPA DE PROFILE CODE - 9145

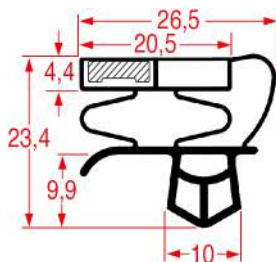

REPA DE PROFILE CODE - 9147

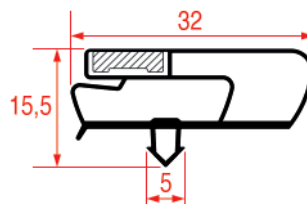

REPA IT PROFILE CODE - 1031
REPA DE PROFILE CODE - 9797

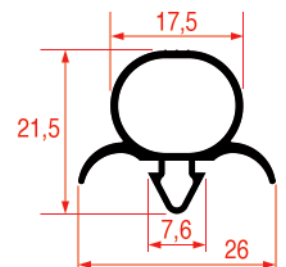

REPA IT PROFILE CODE - 1032
REPA DE PROFILE CODE - 9192

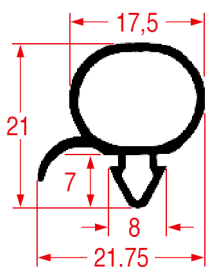

REPA DE PROFILE CODE - 9196

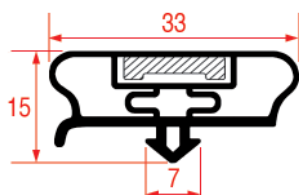

REPA IT PROFILE CODE - 1033
REPA DE PROFILE CODE - 9800

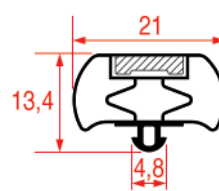

REPA IT PROFILE CODE - 1034
REPA DE PROFILE CODE - 9252

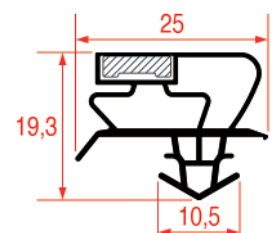

REPA IT PROFILE CODE - 1035
REPA DE PROFILE CODE - 9055

Snap-in gasket profiles

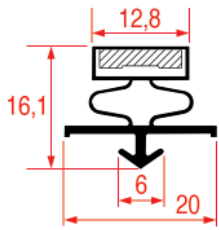

REPA IT PROFILE CODE - 1036
REPA DE PROFILE CODE - 9324

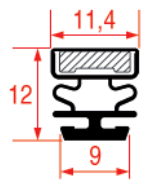

REPA IT PROFILE CODE - 1037
REPA DE PROFILE CODE - 9322

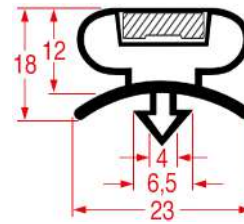

REPA DE PROFILE CODE - 9199

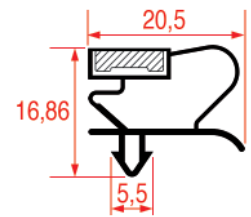

REPA IT PROFILE CODE - 1038
REPA DE PROFILE CODE - 9053

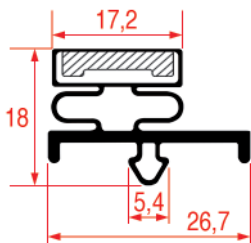

REPA IT PROFILE CODE - 1039
REPA DE PROFILE CODE - 9185

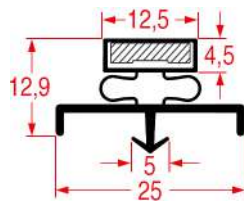

REPA DE PROFILE CODE - 9316

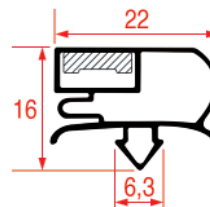

REPA IT PROFILE CODE - 1042
REPA DE PROFILE CODE - 9015

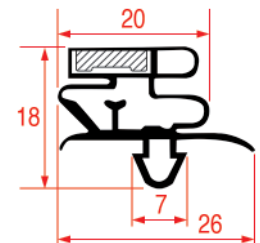

REPA IT PROFILE CODE - 1043
REPA DE PROFILE CODE - 9706

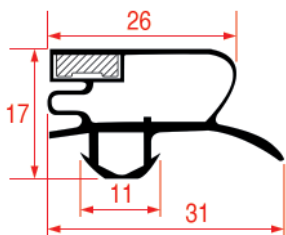

REPA IT PROFILE CODE - 1044
REPA DE PROFILE CODE - 9018

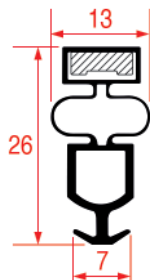

REPA IT PROFILE CODE - 1045
REPA DE PROFILE CODE - 9327

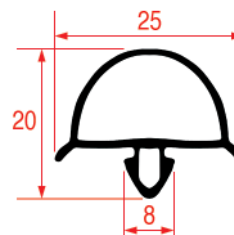

REPA IT PROFILE CODE - 1047
REPA DE PROFILE CODE - 9729

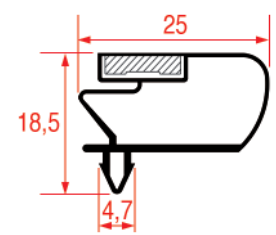

REPA IT PROFILE CODE - 1048
REPA DE PROFILE CODE - 9796

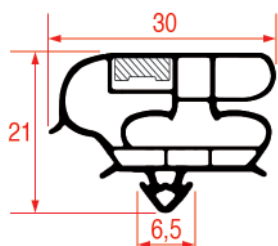

REPA IT PROFILE CODE - 1049
REPA DE PROFILE CODE - 9180

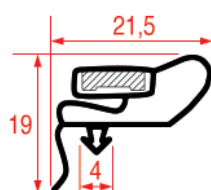

REPA IT PROFILE CODE - 1050
REPA DE PROFILE CODE - 9952

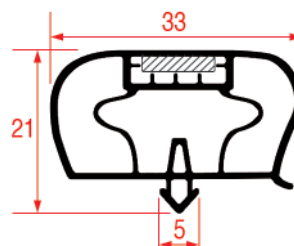

REPA IT PROFILE CODE - 1051
REPA DE PROFILE CODE - 1051

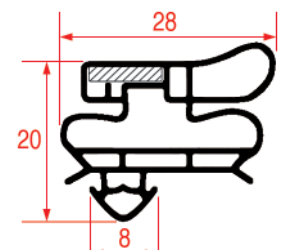

REPA IT PROFILE CODE - 1052
REPA DE PROFILE CODE - 9505

Snap-in gasket profiles

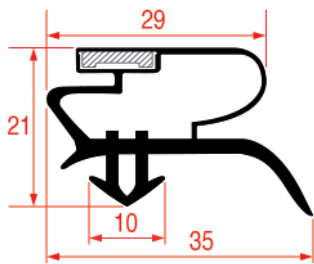

REPA IT PROFILE CODE - 1053
REPA DE PROFILE CODE - 9019

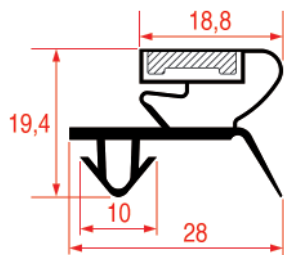

REPA IT PROFILE CODE - 1054
REPA DE PROFILE CODE - 9044

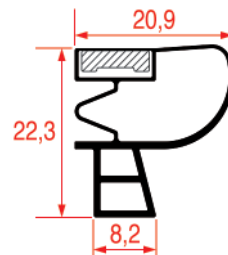

REPA IT PROFILE CODE - 1055
REPA DE PROFILE CODE - 9950

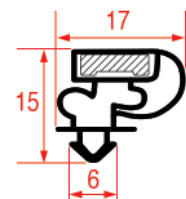

REPA IT PROFILE CODE - 1056
REPA DE PROFILE CODE - 9154

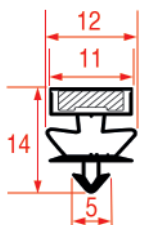

REPA IT PROFILE CODE - 1057
REPA DE PROFILE CODE - 9020

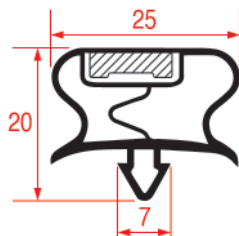

REPA IT PROFILE CODE - 1058
REPA DE PROFILE CODE - 9197

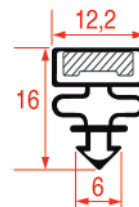

REPA IT PROFILE CODE - 1059
REPA DE PROFILE CODE - 9313

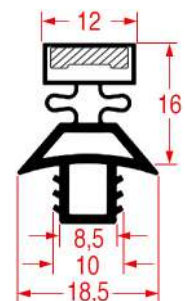

REPA DE PROFILE CODE - 9320

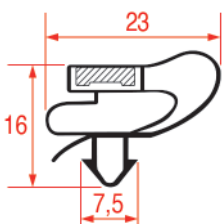

REPA IT PROFILE CODE - 1061
REPA DE PROFILE CODE - 9150

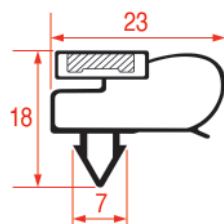

REPA IT PROFILE CODE - 1062
REPA DE PROFILE CODE - 9051

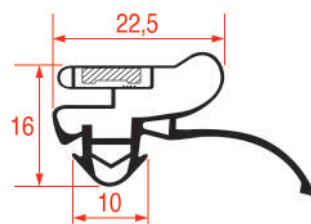

REPA IT PROFILE CODE - 1063
REPA DE PROFILE CODE - 9021

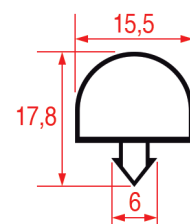

REPA IT PROFILE CODE - 1064
REPA DE PROFILE CODE - 9728

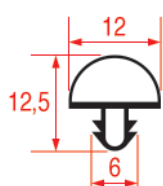

REPA IT PROFILE CODE - 1065
REPA DE PROFILE CODE - 9722

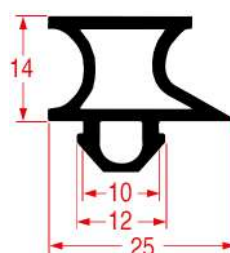

REPA DE PROFILE CODE - 9172

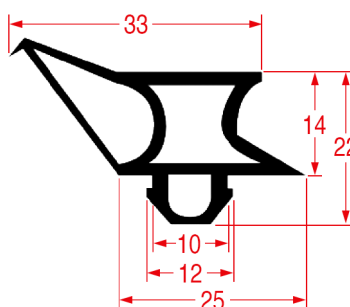

REPA DE PROFILE CODE - 9173

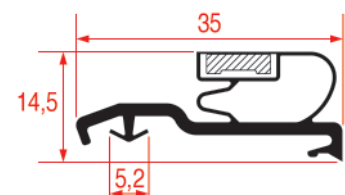

REPA IT PROFILE CODE - 1066
REPA DE PROFILE CODE - 9724

Snap-in gasket profiles

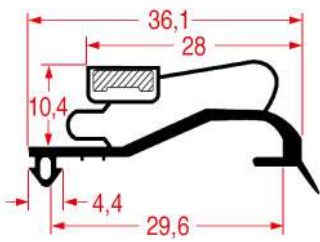

REPA DE PROFILE CODE - 9725

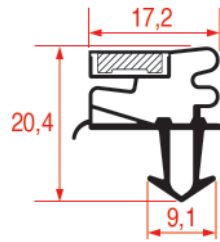

REPA IT PROFILE CODE - 1067
REPA DE PROFILE CODE - 9275

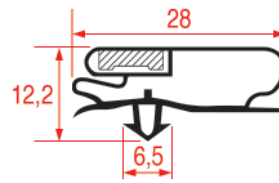

REPA IT PROFILE CODE - 1068
REPA DE PROFILE CODE - 9500

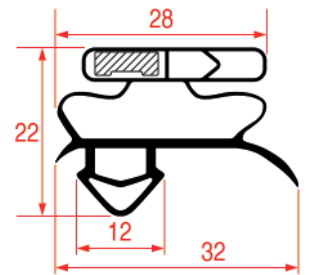

REPA IT PROFILE CODE - 1069
REPA DE PROFILE CODE - 9057

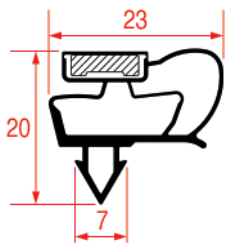

REPA IT PROFILE CODE - 1070
REPA DE PROFILE CODE - 9141

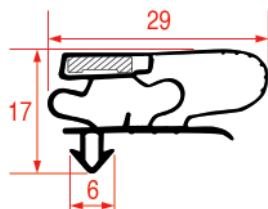

REPA IT PROFILE CODE - 1071
REPA DE PROFILE CODE - 9014

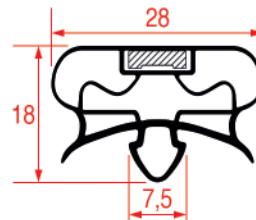

REPA IT PROFILE CODE - 1072
REPA DE PROFILE CODE - 9175

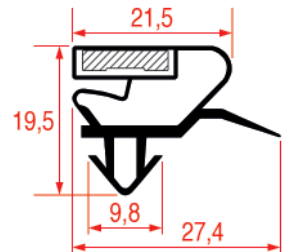

REPA IT PROFILE CODE - 1073
REPA DE PROFILE CODE - 9398

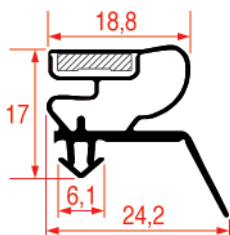

REPA IT PROFILE CODE - 1074
REPA DE PROFILE CODE - 9400

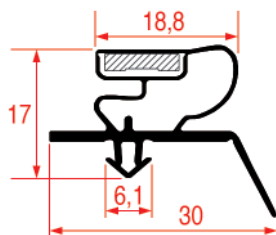

REPA IT PROFILE CODE - 1075
REPA DE PROFILE CODE - 9401

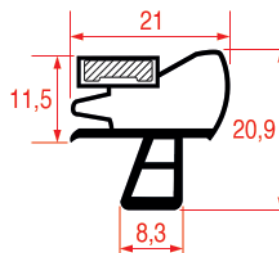

REPA IT PROFILE CODE - 1076
REPA DE PROFILE CODE - 9956

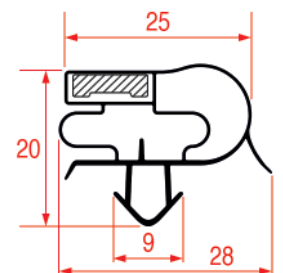

REPA IT PROFILE CODE - 1078
REPA DE PROFILE CODE - 9167



REPA IT PROFILE CODE - 1079
REPA DE PROFILE CODE - 9317

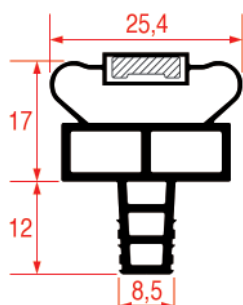

REPA IT PROFILE CODE - 1080
REPA DE PROFILE CODE - 9319

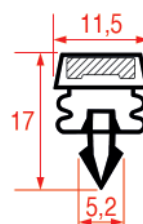

REPA IT PROFILE CODE - 1081
REPA DE PROFILE CODE - 9314

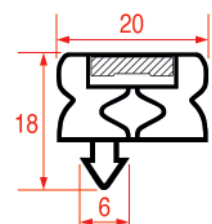

REPA IT PROFILE CODE - 1082
REPA DE PROFILE CODE - 9251

Snap-in gasket profiles

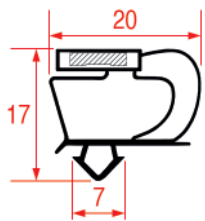

REPA IT PROFILE CODE - 1083
REPA DE PROFILE CODE - 9052

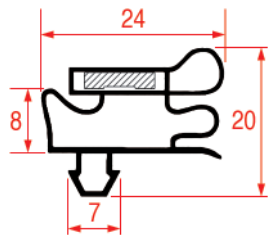

REPA IT PROFILE CODE - 1084
REPA DE PROFILE CODE - 9042

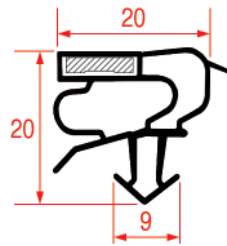

REPA IT PROFILE CODE - 1085
REPA DE PROFILE CODE - 9152

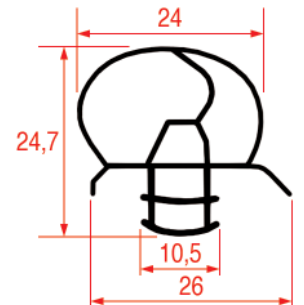

REPA IT PROFILE CODE - 1086
REPA DE PROFILE CODE - 9996

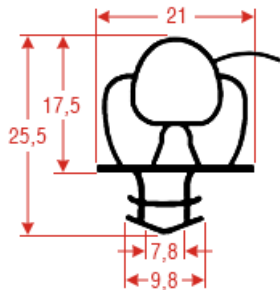

REPA DE PROFILE CODE - 9651

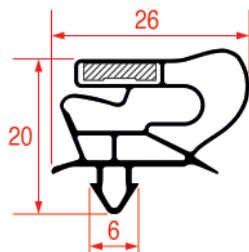

REPA IT PROFILE CODE - 1087
REPA DE PROFILE CODE - 9022

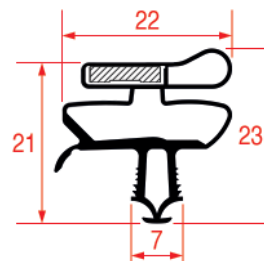

REPA IT PROFILE CODE - 1088
REPA DE PROFILE CODE - 9023

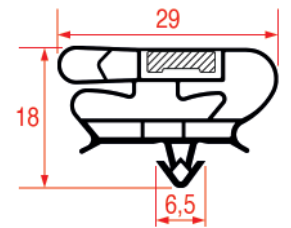

REPA IT PROFILE CODE - 1089
REPA DE PROFILE CODE - 9029

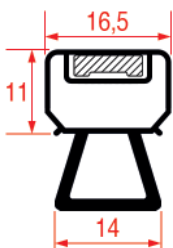

REPA IT PROFILE CODE - 1090
REPA DE PROFILE CODE - 9166

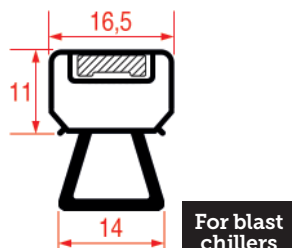

REPA IT PROFILE CODE - 8166
REPA DE PROFILE CODE - 8166

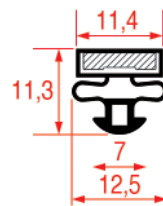

REPA IT PROFILE CODE - 1091
REPA DE PROFILE CODE - 9032

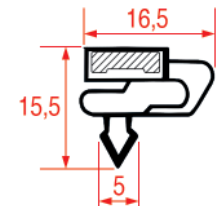

REPA IT PROFILE CODE - 1092
REPA DE PROFILE CODE - 9156

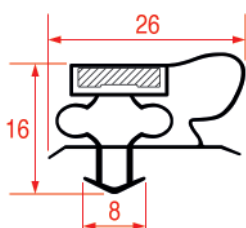

REPA IT PROFILE CODE - 1093
REPA DE PROFILE CODE - 9157

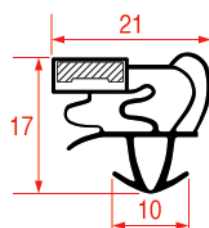

REPA IT PROFILE CODE - 1094
REPA DE PROFILE CODE - 9033

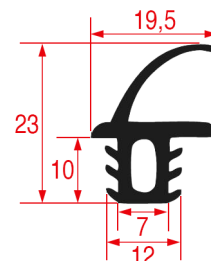

REPA DE PROFILE CODE - 9299

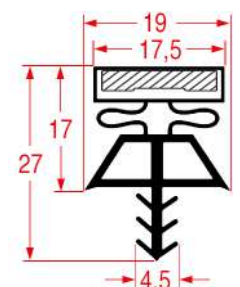

REPA DE PROFILE CODE - 9321

Snap-in gasket profiles

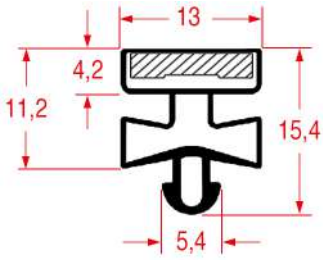

REPA DE PROFILE CODE - 9380

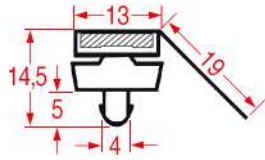

REPA DE PROFILE CODE - 9385

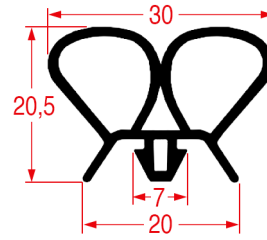

REPA DE PROFILE CODE - 9938

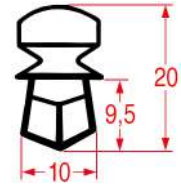

REPA DE PROFILE CODE - 9978

Middle-edge gasket profiles

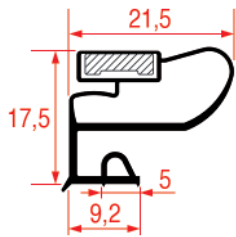

REPA IT PROFILE CODE - 2001
REPA DE PROFILE CODE - 9663

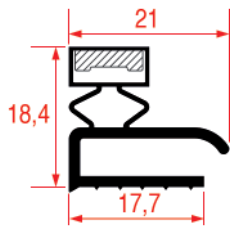

REPA IT PROFILE CODE - 2002
REPA DE PROFILE CODE - 9106

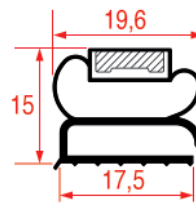

REPA IT PROFILE CODE - 2003
REPA DE PROFILE CODE - 9207

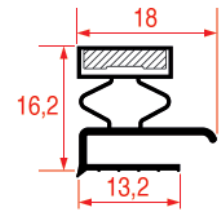

REPA IT PROFILE CODE - 2004
REPA DE PROFILE CODE - 9031

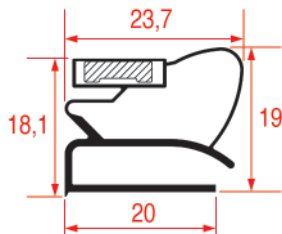

REPA IT PROFILE CODE - 2005
REPA DE PROFILE CODE - 9954

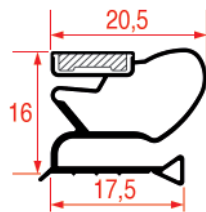

REPA IT PROFILE CODE - 2007
REPA DE PROFILE CODE - 9515

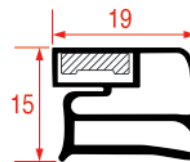

REPA IT PROFILE CODE - 2008
REPA DE PROFILE CODE - 9458

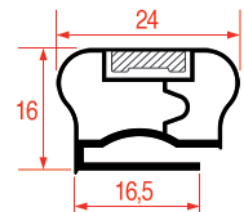

REPA IT PROFILE CODE - 2009
REPA DE PROFILE CODE - 9200

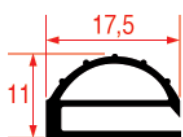

REPA IT PROFILE CODE - 2010
REPA DE PROFILE CODE - 9102

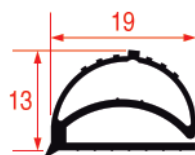

REPA IT PROFILE CODE - 2011
REPA DE PROFILE CODE - 9158

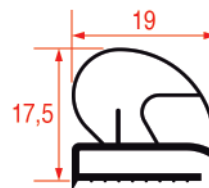

REPA IT PROFILE CODE - 2012
REPA DE PROFILE CODE - 9710

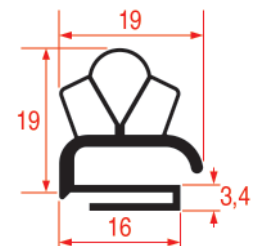

REPA IT PROFILE CODE - 2013
REPA DE PROFILE CODE - 9138

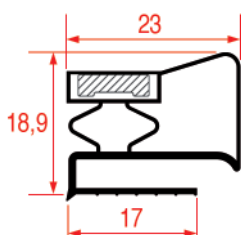

REPA IT PROFILE CODE - 2014
REPA DE PROFILE CODE - 9953

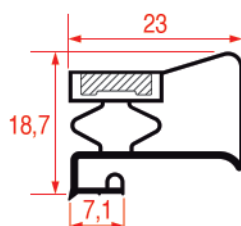

REPA IT PROFILE CODE - 2015
REPA DE PROFILE CODE - 9949

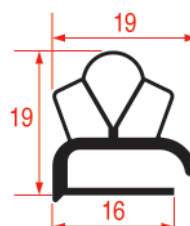

REPA IT PROFILE CODE - 2016
REPA DE PROFILE CODE - 9191

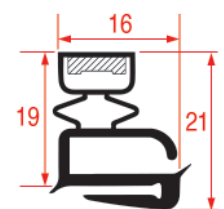

REPA IT PROFILE CODE - 2017
REPA DE PROFILE CODE - 9100

Middle-edge gasket profiles

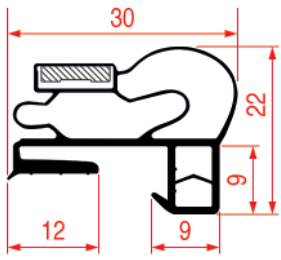

REPA IT PROFILE CODE - 2018
REPA DE PROFILE CODE - 9034

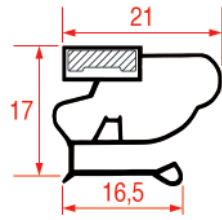

REPA IT PROFILE CODE - 2019
REPA DE PROFILE CODE - 9135

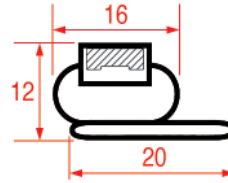

REPA IT PROFILE CODE - 2021
REPA DE PROFILE CODE - 9968

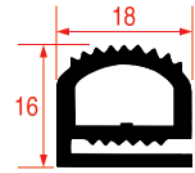

REPA IT PROFILE CODE - 2022
REPA DE PROFILE CODE - 9170

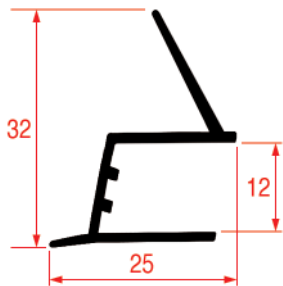

REPA IT PROFILE CODE - 2023
REPA DE PROFILE CODE - 9910

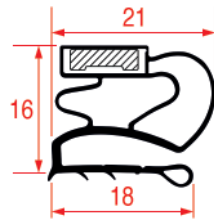

REPA IT PROFILE CODE - 2024

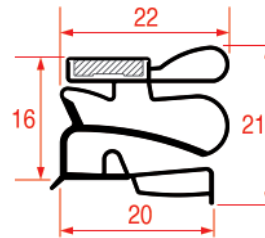

REPA IT PROFILE CODE - 2025
REPA DE PROFILE CODE - 9035

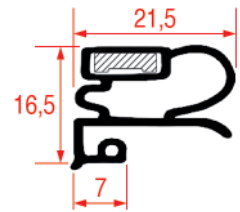

REPA IT PROFILE CODE - 2026
REPA DE PROFILE CODE - 9030



100+
Gaskets profiles
available!

Your perfect refrigeration gasket, made to order

At REPA, discover over **100 gasket profiles** always in stock, catering to all your refrigeration needs.

Plus, with our intuitive online configurator, you can personalize your gasket and have it hand within **just a few days**.

www.repagroup.com

 **REPA**
A Parts Town unlimited Company



REPA IT



REPA DE

